

PRODUZIONE FLESSIBILE E INNOVATIVA

DAL 1977

ACCESSORI PER ESPOSITORI
E PER IL PUNTO VENDITA

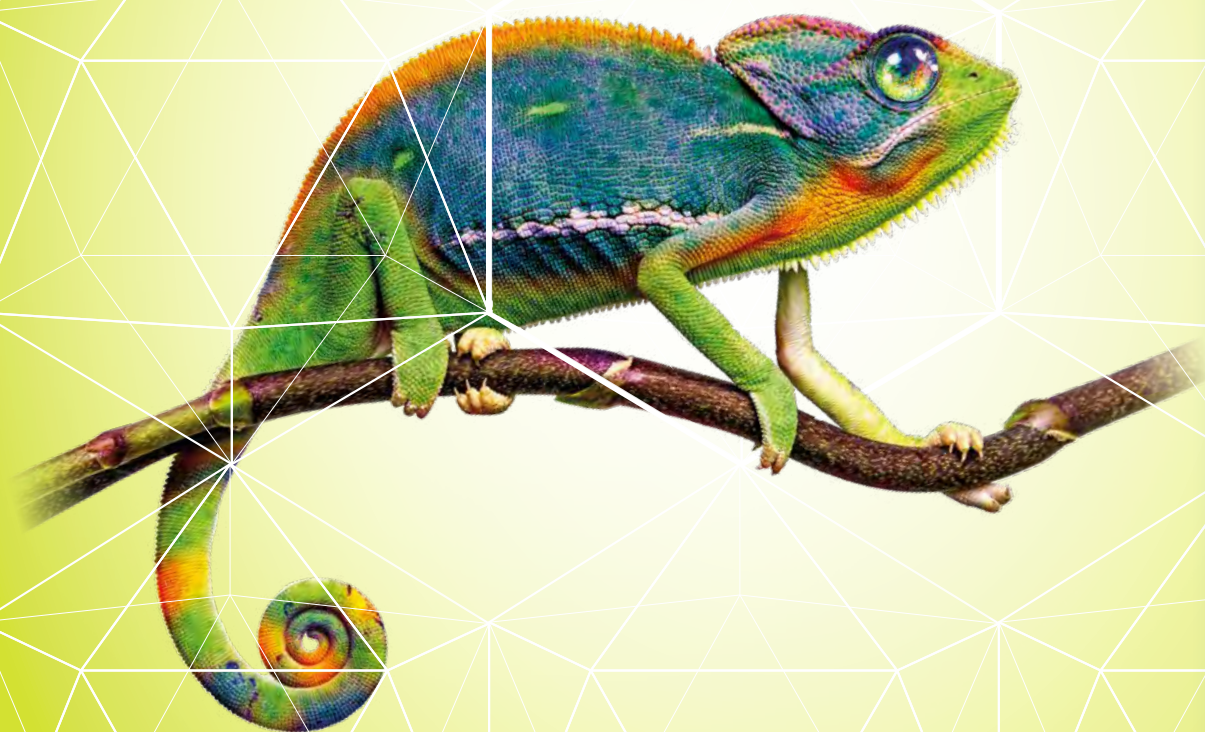

2021•3

 0332 420711
syncopop.it

 **SYNCO**[®]
display & pop accessories



I NOSTRI PUNTI DI FORZA

PROGETTIAMO
NUOVE E CREATIVE
SOLUZIONI

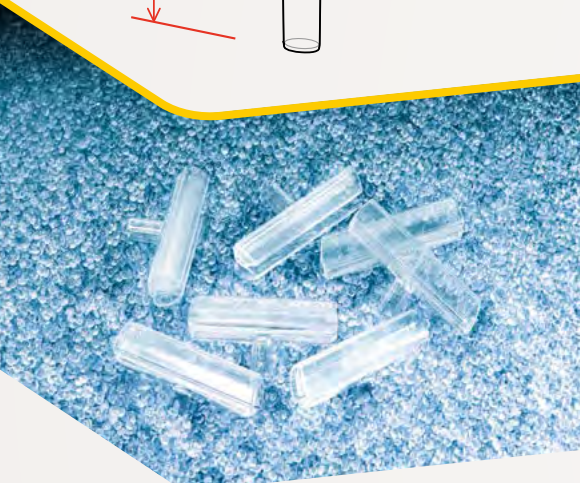
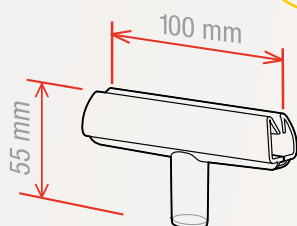

PRODUZIONE INTERNA

KNOW-HOW E PRODUZIONE IN CONTINUA
EVOLUZIONE DAL 1977

LE NOSTRE TIPOLOGIE DI PRODUZIONE



PIEGA MANUALE ED AUTOMATICA / ESTRUSIONE / STAMPAGGIO AD INIEZIONE / TAGLIO A FRESA / LASER



8.400 mq DI PRODUZIONE E STOCK

**CHIAMACI
0332 420711**

Lun-Gio 8:00 - 12:30 / 13:45 - 17:30
Ven 8:00 - 12:30 / 13:45 - 16:15

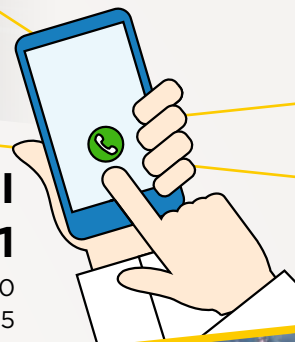

L'IMPEGNO GREEN

SYNCO È VICINA ALL'AMBIENTE UTILIZZANDO ENERGIA SOLARE PER LA PRODUZIONE E RICICLANDO IL MATERIALE DI SCARTO PER PRODURRE ALTRI ARTICOLI.



STOCK



PIÙ DI 2000 PRODOTTI IN PRONTA CONSEGNA

da
pag.

04 GANCI BROCHES PORTA BLISTER

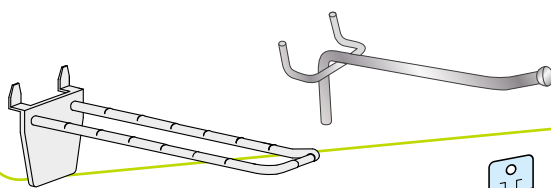

09 ACCESSORI PER GANCI
limitatori di scorta, porta etichetta,
antifurti, ganci adesivi, supporti e
strisce porta blister

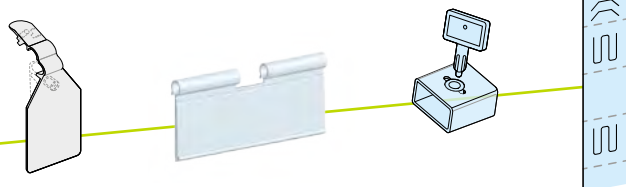

16 CLIP/RIVETTI
per assemblaggio
espositori / campionari

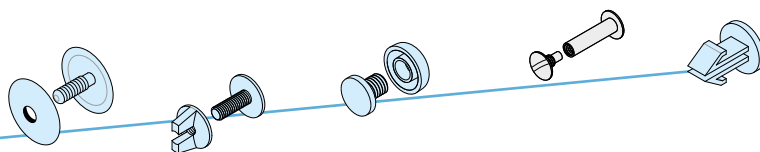

18 PROFILI
portaprezzo
per category
da assemblare

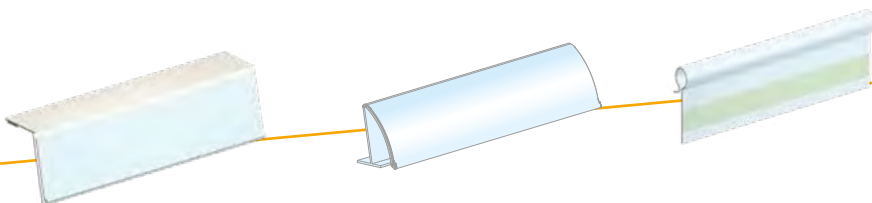

21 SEPARATORI
per esposizione prodotti

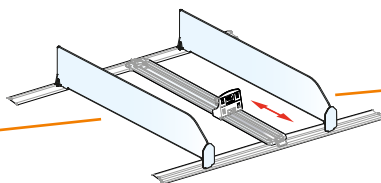

22 PORTA BANNER e PORTA STOP
per comunicazione frontale e a bandiera

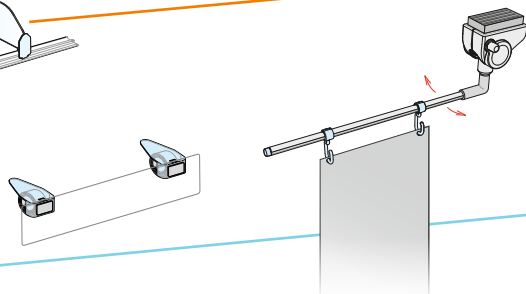

27 GRIPPER

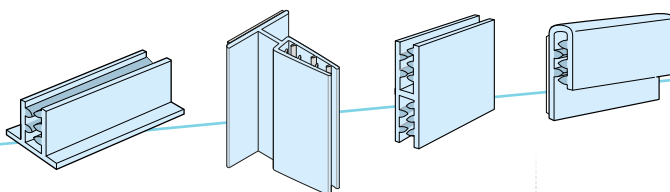

29 PORTA MESSAGGI

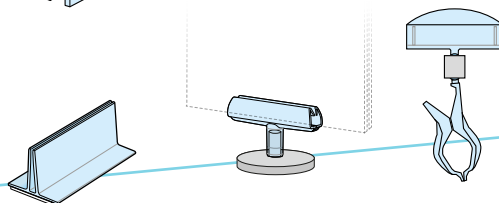

33 PORTA POSTER

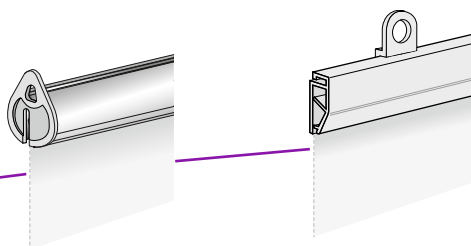

da
pag.

06

**GANCI BROCHE
CON ATTACCO
A PINZA**

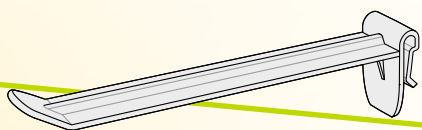

15

CLIP GREEN PER
ASSEMBLAGGIO RIPIANI

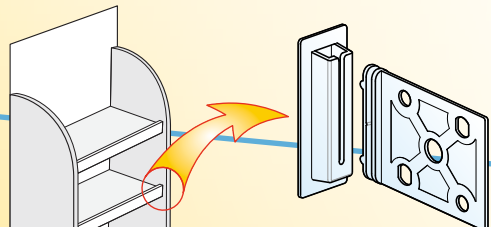

FASTY

16

**RIVETTO A PRESSIONE
RIUTILIZZABILE**

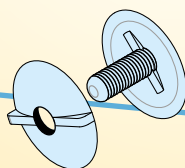

34

**SISTEMA A SOSPENSIONE
stylebar**

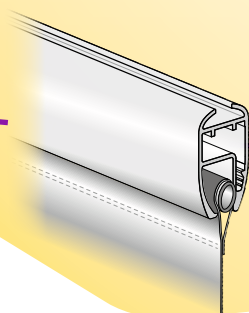

pag

38

**ACCESSORI
PER SOSPENSIONE ED UNIONE
ANELLI E VENTOSE**

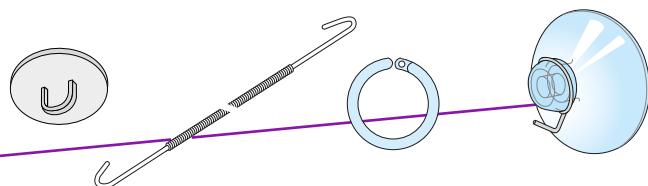

43

**CORDONCINI / ELASTICI
LACCI / BUSTINE / MANIGLIE
ANTIFURTI / PASTIGLIE MAGNETICHE
BASI GIREVOLI**

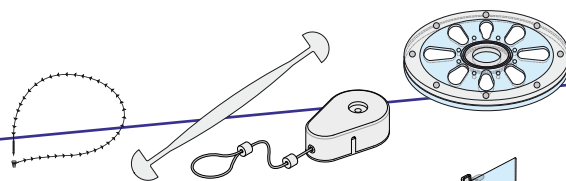

46

**PORTA MESSAGGI E BROCHURES
PORTANOME**

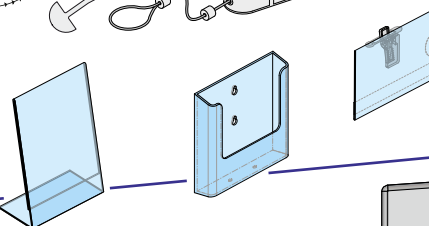

50

**CORNICI E PIANTANE
E ACCESSORI**

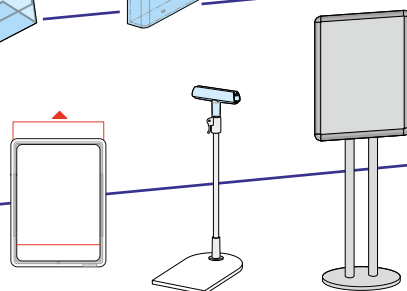

53

**BANDA MAGNETICA, BIADESIVO, VELCRO
PIEDINI ANTISDRUCCIOLO**

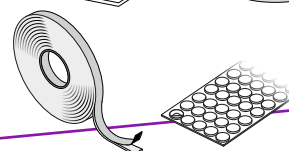



1 Gancio broche singolo in plastica - ad inserimento automatico

Gancio porta blister dotato di punte posteriori che permettono di forare il cartone escludendo la fustellatura.

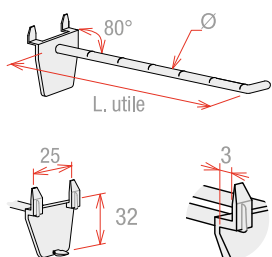

code	L. utile	Ø	colore	pack
	mm	mm		pcs/box
25126050	50	6,0	Bianco	==
25126100	100	6,0	Bianco	==
25126150	150	6,0	Bianco	==
25126200	200	6,0	Bianco	==

DESIGN plus

con fronte arrotondato predisposto per etichetta prezzo.
In plastica rinforzata per una tenuta ottimale.

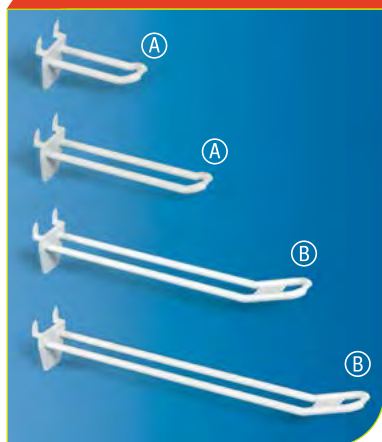

2 Gancio broche doppio in plastica - ad inserimento automatico

Gancio porta blister dotato di punte posteriori che permettono di forare il cartone escludendo la fustellatura.
Porta etichette opzionale vedi code 2512484.

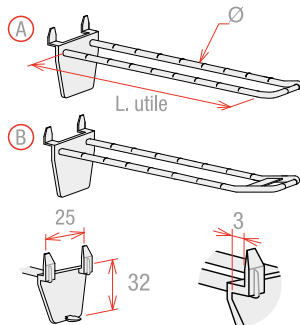

code	modello	L. utile	Ø	colore	pack
		mm	mm		pcs/box
25125050	A	50	5,0	Bianco	==
25125100	A	100	5,0	Bianco	==
25125150	B	150	5,0	Bianco	==
25125200	B	200	5,0	Bianco	==

Accessori

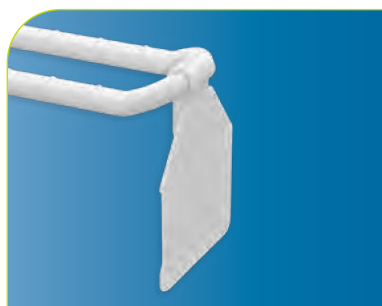

3 Porta etichetta per gancio doppio in plastica

Da posizionare sul fronte del gancio doppio.

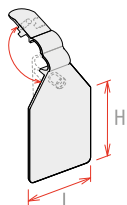

code	LxH.	colore	pack
	mm		pcs/box
2512484	27 xH.27	Bianco	100



4 Limitatore di scorta per gancio doppio

Per regolare l'esposizione dei prodotti sui ganci doppi a seconda dello spessore, del peso e della loro rotazione.

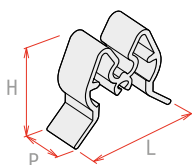

code	LxPxH.	colore	pack
	mm		pcs/box
842664	35x10xH.27	Bianco	100

Altri colori su richiesta 

Gancio con copertura totale del foro Scalino posteriore anti-fuoriuscita



5 Gancio broche singolo in plastica - con attacco a pinza

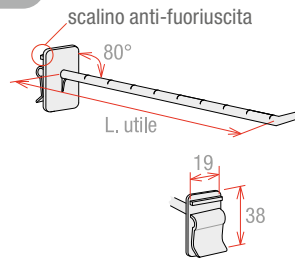

Gancio porta blister in plastica con attacco a pinza per spessore max. 4 mm.

code	L. utile mm	Ø mm	colore	pack pcs/box
2513050	50	6,0	Bianco	==
2513100	100	6,0	Bianco	==
2513150	150	6,0	Bianco	==

6 Gancio broche largo in plastica - con attacco a pinza

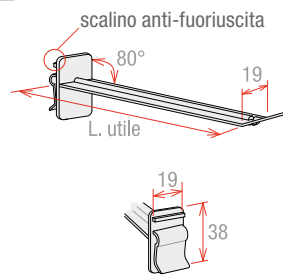
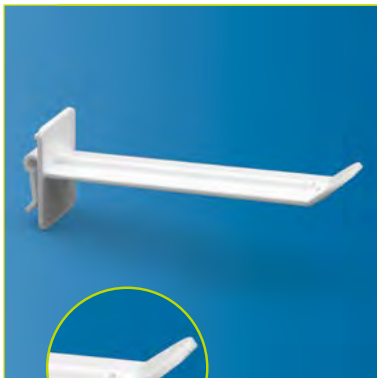

Gancio porta blister in plastica con attacco a pinza per spessore max. 4 mm.

code	con intaglio	L. utile mm	colore	pack pcs/box
2512010	-	10	Bianco	==
2512020	-	20	Bianco	==
2512050	-	50	Bianco	==
2512070	-	70	Bianco	==
2512100	✓	100	Bianco	==
2512120	✓	120	Bianco	==
2512150	✓	150	Bianco	==
2512170	✓	170	Bianco	==
2512190	✓	190	Bianco	==
2512210	✓	210	Bianco	==
2512250	✓	250	Bianco	==

Intaglio per FERMA PRODOTTI
opzionale anti-caduta per un
trasporto sicuro

Accessori

7 Blocco FERMA PRODOTTI per gancio largo in plastica

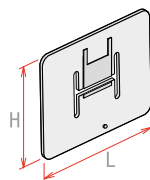

Blocco ferma prodotti in plastica colore rosso, per gancio porta blister largo in plastica.

code	LxH. mm	colore	pack pcs/box
251245	45 x H.36	Rosso	==

8 Limitatore di scorta per gancio singolo e largo in plastica

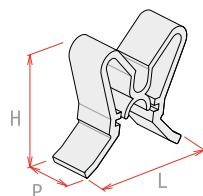

Per regolare l'esposizione dei prodotti sui ganci singoli e larghi, a seconda dello spessore, del peso e della loro rotazione.

code	LxPxH. mm	colore	pack pcs/box
842665	32 x 10 x H.30	Bianco	==



9 Gancio broche singolo in plastica - con attacco a pinza

Gancio porta blister in plastica con attacco a pinza per spessore max. 4 mm.

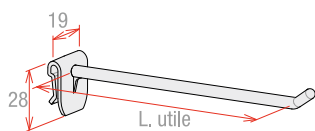

code	L. utile	colore	pack
	mm		pcs/box
311050WH	50	Bianco	==
311050BK	50	Nero	==
311050TR	50	Trasparente	==
311100WH	100	Bianco	==
311100BK	100	Nero	==
311100TR	100	Trasparente	==
311150WH	150	Bianco	==
311150BK	150	Nero	==
311150TR	150	Trasparente	==



10 Gancio broche largo in plastica - con attacco a pinza

Gancio porta blister in plastica con attacco a pinza per spessore max. 4 mm.

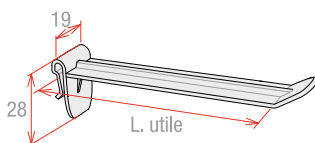

code	L. utile	colore	pack
	mm		pcs/box
312020WH	20	Bianco	==
312020BK	20	Nero	==
312020TR	20	Trasparente	==
312050WH	50	Bianco	==
312050BK	50	Nero	==
312050TR	50	Trasparente	==
312070WH	70	Bianco	==
312070BK	70	Nero	==
312070TR	70	Trasparente	==
312100WH	100	Bianco	==
312100BK	100	Nero	==
312100TR	100	Trasparente	==
312120WH	120	Bianco	==
312120BK	120	Nero	==
312120TR	120	Trasparente	==
312150WH	150	Bianco	==
312150BK	150	Nero	==
312150TR	150	Trasparente	==
312170WH	170	Bianco	==
312170BK	170	Nero	==
312170TR	170	Trasparente	==



11 Gancio broche singolo in plastica - con attacco per pannelli forati

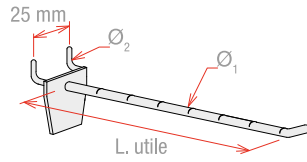

code	L. utile	Ø ₁	Ø ₂	colore	pack
	mm	mm	mm		pcs/box
25146050	50	6,0	4,5	Bianco	==
25146100	100	6,0	4,5	Bianco	==
25146150	150	6,0	4,5	Bianco	==
25146200	200	6,0	4,5	Bianco	==

DESIGN plus

con fronte arrotondato predisposto per etichetta prezzo.
In plastica rinforzata per una tenuta ottimale.

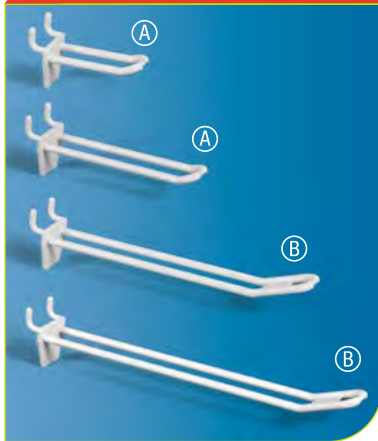

12 Gancio broche doppio in plastica - con attacco per pannelli forati

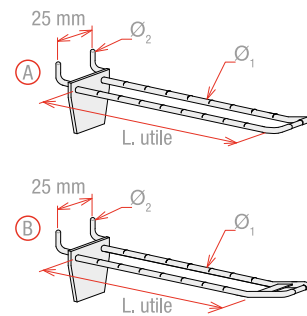

code	modello	L. utile	Ø ₁	Ø ₂	colore	pack
		mm	mm	mm		pcs/box
25145050	A	50	5,5	4,5	Bianco	==
25145100	A	100	5,5	4,5	Bianco	==
25145150	B	150	5,5	4,5	Bianco	==
25145200	B	200	5,5	4,5	Bianco	==

Accessori

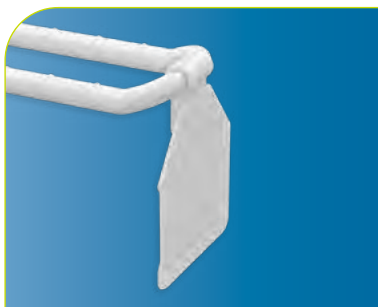

13 Porta etichetta per gancio doppio in plastica



Da posizionare sul fronte del gancio doppio.

code	LxH.	colore	pack
	mm		pcs/box
2512484	27 x H.27	Bianco	100



14 Limitatore di scorta per gancio doppio

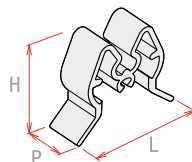

Per regolare l'esposizione dei prodotti sui ganci doppi a seconda dello spessore, del peso e della loro rotazione.

code	LxPxH.	colore	pack
	mm		pcs/box
842664	35 x 10 x H.27	Bianco	100

Altri modelli disponibili su www.synco.it

15 Gancio broche singolo in filo metallico Ø3,8 mm

In ferro zincato con punta antinfortunistica.

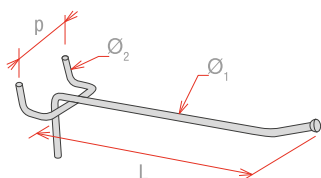
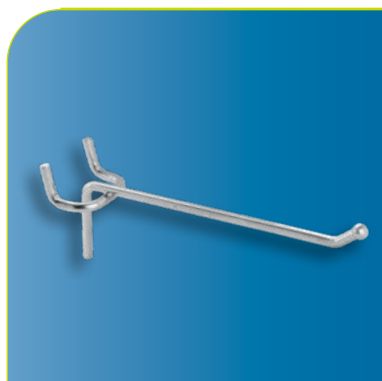

code	L.	p	Ø ₁	Ø ₂	pack
	mm	mm	mm	mm	pcs/box
25113806	60	25	3,8	3,8	100
25113808	80	25	3,8	3,8	100
25113812	120	25	3,8	3,8	100
25113816	160	25	3,8	3,8	100
25113820	200	25	3,8	3,8	100

16 Gancio broche singolo in filo metallico Ø5 mm

In ferro zincato con punta antinfortunistica.

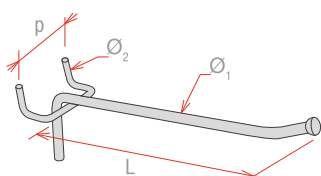

code	L.	p	Ø ₁	Ø ₂	pack
	mm	mm	mm	mm	pcs/box
25114010	100	25	5,0	3,8	50
25114015	150	25	5,0	3,8	50
25114020	200	25	5,0	3,8	50
25114025	250	25	5,0	3,8	50
25114030	300	25	5,0	3,8	50

17 Gancio broche doppio in filo metallico Ø3,8 mm

In ferro zincato.

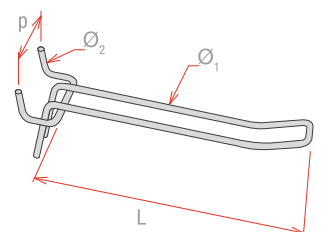
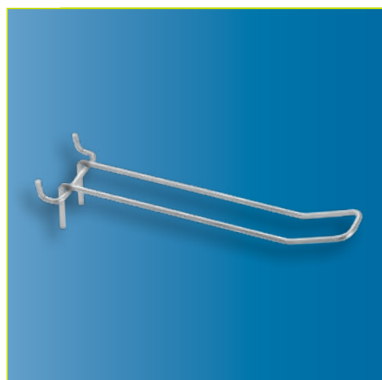

code	L.	p	Ø ₁	Ø ₂	pack
	mm	mm	mm	mm	pcs/box
25110210	100	50	3,8	3,8	50
25110215	150	50	3,8	3,8	50
25110220	200	50	3,8	3,8	50
25110225	250	50	3,8	3,8	50
25110230	300	50	3,8	3,8	50

18 Gancio broche semplice doppio in filo metallico Ø3,8 mm

In ferro zincato.

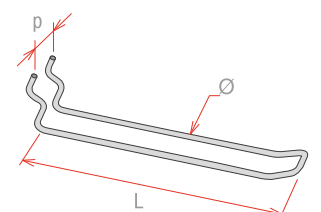
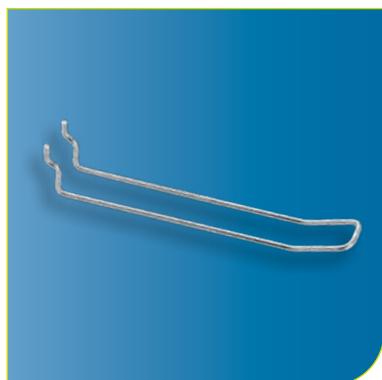

code	L.	p	Ø	pack
	mm	mm	mm	pcs/box
25110005	50	25	3,8	50
25110010	100	25	3,8	50
25110015	150	25	3,8	50
25110020	200	25	3,8	50
25110025	250	25	3,8	50
25110030	300	25	3,8	50

Limitatori di scorta



19 Limitatore di scorta per gancio singolo

Per regolare l'esposizione dei prodotti sui ganci a seconda dello spessore, del peso e della loro rotazione.

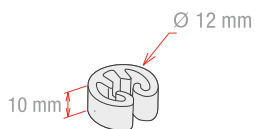

code	Ø max	colore	pack
	mm		pcs/box
842638	6	Bianco	1000



20 Limitatore di scorta per gancio doppio

Per regolare l'esposizione dei prodotti sui ganci doppi a seconda dello spessore, del peso e della loro rotazione.

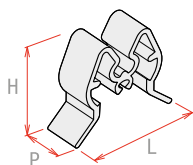

code	LxPxH.	colore	pack
	mm		pcs/box
842664	35x10xH.27	Bianco	100

Porta etichetta



21 Porta etichetta per etichetta adesiva

Da posizionare sul fronte del gancio (Ø max 6 mm). In colore nero su richiesta.

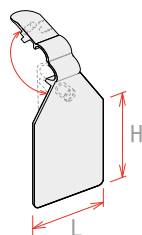

code	Lx H.	Ø max	colore	pack
	mm	mm	mm	pcs/box
251148WH	27 x H.27	6	Bianco	100
251149WH	25 x H.38	6	Bianco	100



22 Porta etichetta trasparente per etichetta non adesiva

Apertura posteriore. Da posizionare sul fronte del gancio.

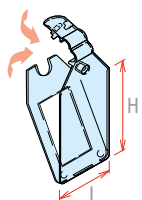

code	Lx H.	Ø max	colore	pack
	mm	mm	mm	pcs/box
251144	25 x H.27	6	Trasparente	100
251145	25 x H.38	6	Trasparente	100



23 Tasca porta etichetta a "T" per ganci

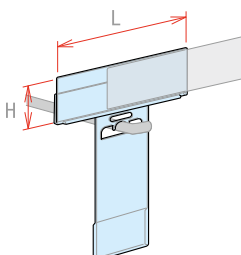

code	Lx H.	colore	pack
	mm		pcs/box
251042	110xH.40	Trasparente	100

Taglio in linea: garanzia di qualità
 Ampia gamma in stock per consegne veloci
 Altri modelli disponibili su www.synco.it

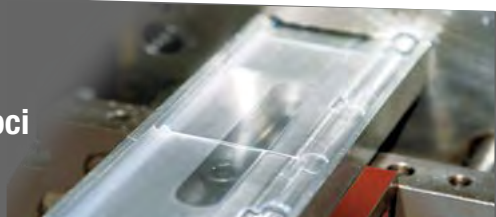

24 Porta etichetta basculante per gancio broche - apertura frontale

In PVC estruso, per etichetta 75 x H.26 mm.
 Taglio centrale da 10 mm, per gancio Ø max 6 mm.

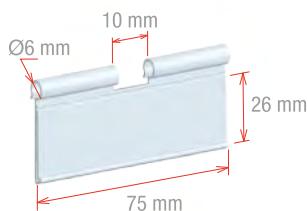

code	etichetta	taglio	colore	pack
	mm	mm		pcs/box
LHH08010TR75	75 x H.26	10	Transparente	1000



25 Porta etichetta basculante per gancio broche - apertura frontale

In PVC estruso, per etichetta 75 x H.32 mm.
 Taglio centrale da 9 mm, per gancio Ø max 7 mm.

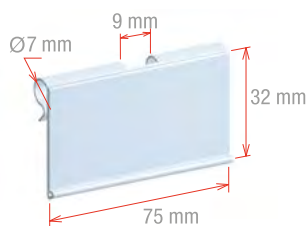

code	etichetta	taglio	colore	pack
	mm	mm		pcs/box
LHH05009TR75	75 x H.32	9	Transparente	1000



26 Porta etichetta basculante per gancio broche - apertura posteriore

In PVC estruso, per etichetta da 65 x H.39 mm.
 Senza taglio centrale, per gancio Ø max 7 mm.

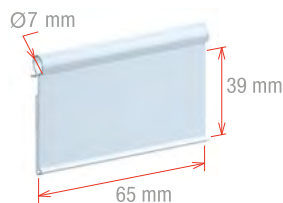

code	etichetta	taglio	colore	pack
	mm	mm		pcs/box
LHH02000TR65	65 x H.39	-	Transparente	1000



27 Porta etichetta basculante per gancio broche - apertura posteriore

In PVC estruso, per etichetta H.39 mm.
 Taglio centrale da 9 mm, per gancio Ø max 7 mm.

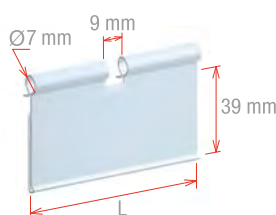

code	etichetta	taglio	colore	pack
	mm	mm		pcs/box
LHH02009TR50	50 x H.39	9	Transparente	1000
LHH02009TR65	65 x H.39	9	Transparente	1000
LHH02009TR70	70 x H.39	9	Transparente	1000
LHH02009TR75	75 x H.39	9	Transparente	1000

Antitaccheggio



28

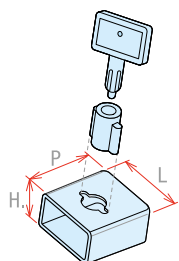

Antitaccheggio per gancio doppio

Antitaccheggio con serratura in plastica per proteggere i prodotti sui ganci doppi. Comprensivo di chiave.

code	LxPxH. mm	colore	pack pcs/box
842652	33 x 33 x H.19	Trasparente	50
842650	33 x 33 x H.19	Grigio	50



29

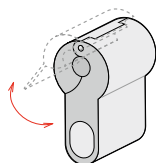

Antitaccheggio magnetico per gancio

Antitaccheggio a chiave magnetica, per proteggere i prodotti sia su ganci singoli che doppi (Ø max 6 mm).

code	Ø mm	colore	pack pcs/box
842656	6	Bianco	50
842658	6	Nero	50



30

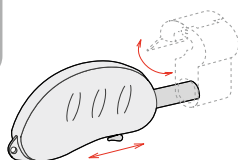

Dispositivo di sbloccaggio con chiave magnetica estraibile

code	colore	pack pcs/box
842659	Nero	10

Ganci adesivi per blister



31

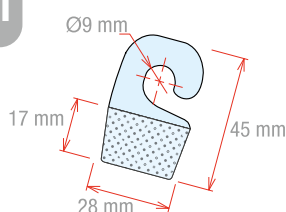

Gancio adesivo aperto per ganci singoli

Per appendere prodotti e poterli sganciare di lato. La parte adesiva è flessibile.

code	carico max g	colore mm	rotolo pcs/box
251052	250	Trasparente	3000



32

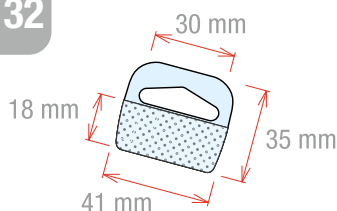

Gancio adesivo chiuso per ganci singoli o doppi

Per appendere prodotti a ganci. La parte adesiva è rigida.

code	carico max g	colore mm	rotolo pcs/box
251054	750	Trasparente	2500

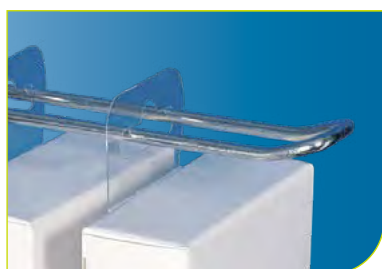

33

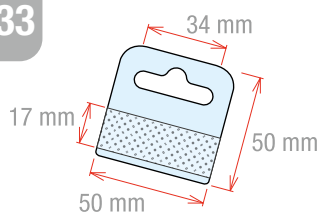

Gancio adesivo chiuso per prodotti pesanti, per ganci singoli o doppi

Per appendere ai ganci prodotti più pesanti, come libri, ecc. Con adesivo schiuma. La parte adesiva è rigida.

code	carico max g	colore mm	rotolo pcs/box
251056	1250	Trasparente	1000



34

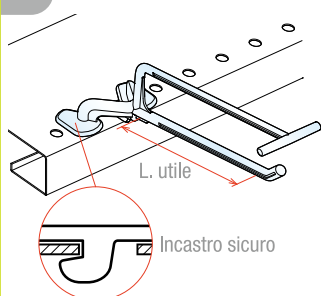

Cross-Hook - porta blister da scaffale

Si aggancia ai fori della maggioranza delle scaffalature. Si consiglia di usare pesi non superiori a 500 g. Dotato di asta a "T" per vari tipi di porta etichette (venduti separatamente).

code	L. utile	colore	pack
	mm		pcs/box
251900	90	Trasparente	20



35

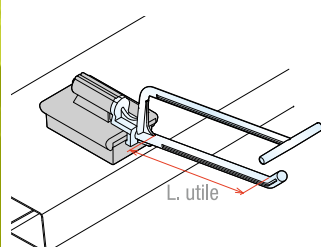

Cross-Hook - porta blister con attacco magnetico sopra ripiano

Magnete in ferrite, si consiglia di usare pesi non superiori a 550/600 g. Dotato di asta a "T" per vari tipi di porta etichette (venduti separatamente).

code	L. utile	colore	pack
	mm		pcs/box
251902	90	Grigio / Trasparente	20



36

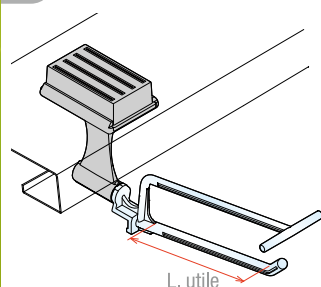

Cross-Hook - porta blister con attacco magnetico sotto ripiano

Magnete in ferrite, si consiglia di usare pesi non superiori a 550/600 g. Dotato di asta a "T" per vari tipi di porta etichette (venduti separatamente).

code	L. utile	colore	pack
	mm		pcs/box
251906	90	Grigio / Trasparente	20



37

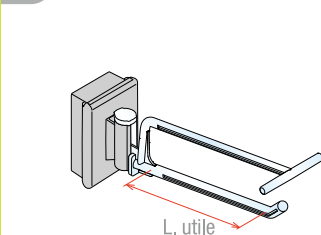

Cross-Hook - porta blister con attacco magnetico verticale

Magnete in ferrite, dotato di asta a "T" per vari tipi di porta etichette (venduti separatamente).

code	L. utile	colore	pack
	mm		pcs/box
251904	90	Grigio / Trasparente	20



38

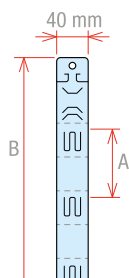

Striscia porta blister in PP leggero 12 posti

In polipropilene, spessore 0,8 mm.

code	asole	A	B	pack
	mm	mm	mm	pcs/box
111646	12	65	825	50

NEW



39

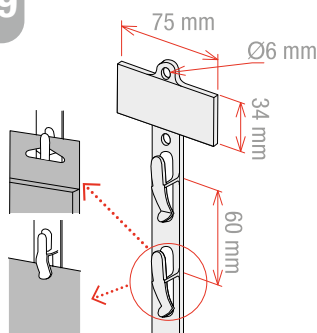

Striscia porta blister bianca con porta etichette

I ganci sono a doppia funzione. Nella parte alta i blister con foro vengono appesi, nella parte inferiore i sacchetti vengono pinzati. Le strisce possono essere allungate con il prodotto nr. 40.

code	ganci	lunghezza	porta etichetta	colore	pack
	nr	mm			pcs/box
117770	6	425	✓	Bianco	20
117774	8	545	✓	Bianco	20
117778	12	790	✓	Bianco	20

NEW



40

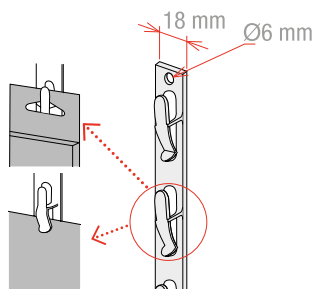

Striscia porta blister bianca senza porta etichette

I ganci sono a doppia funzione. Nella parte alta i blister con foro vengono appesi, nella parte inferiore i sacchetti vengono pinzati.

code	ganci	lunghezza	porta etichetta	colore	pack
	nr	mm			pcs/box
117772	6	375	-	Bianco	20
117776	8	495	-	Bianco	20
117780	12	740	-	Bianco	20



41

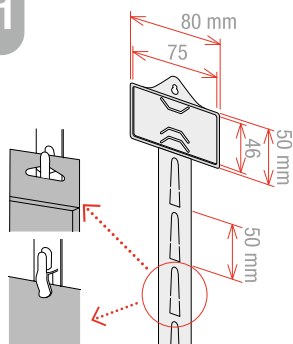

Striscia "ECO" porta blister bianca 2 funzioni

Nella parte alta i blister con foro vengono appesi, nella parte inferiore i sacchetti vengono pinzati.

Ha un intaglio per etichette prezzo H.34 o 42 mm. Colorata e personalizzata su richiesta.

code	asole	passo	lunghezza	colore	pack
	mm	mm	mm		pcs/box
111652	12	50	670	Bianco	20



42

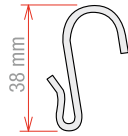

Gancio ad "S" in metallo anti-fuoriuscita

Da utilizzare con la striscia per un'esposizione sicura.

code	H.	materiale	pack
	mm		pcs/box
721030	38	metallo	==



43

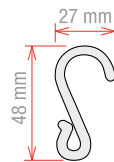

Gancio ad "S" in plastica anti-fuoriuscita

Da utilizzare con la striscia per un'esposizione sicura.

code	H.	colore	pack
	mm		pcs/box
721032	48	Bianco	==



44

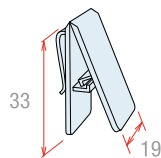

Clip pinza confezione



Per appendere confezioni senza foro. Da applicare su strisce o pannelli. Strisce/pannelli su richiesta. Altre colorazioni su richiesta.

code	colore	pack
		pcs/box
111802	Traslucido	100

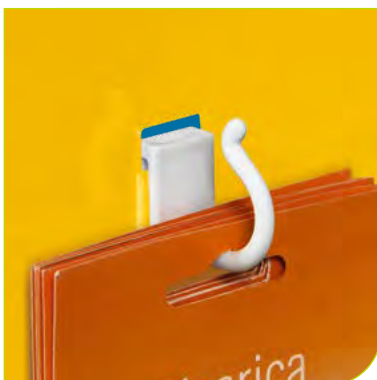

45

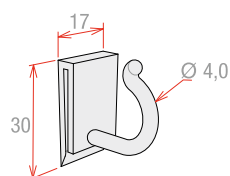

Gancio ad uncino con attacco a pinza

Broche porta blister, sacchetti o coupons. Disponibile con o senza biadesivo schiuma sul retro.

code	adesivo	colore	pack
			pcs/box
111804	senza adesivo schiuma	Bianco	==
111804AS	con adesivo schiuma	Bianco	==

La soluzione
FACILE e VELOCE
ECONOMICA e SICURA
per il montaggio dei ripiani sui lati del display

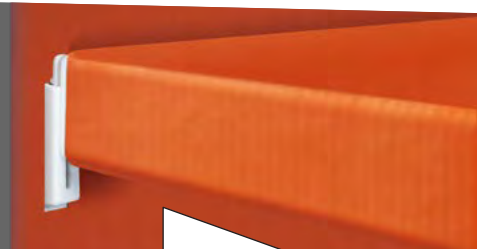

clip **FASTY**

Garantendo un'ottima tenuta del ripiano sul montante, permette di esporre i prodotti in modo sicuro e più durevole.

Costituita da 2 pezzi:

- 1 si monta tramite colla a caldo nel ripiano sagomato
- 2 si monta ad incastro nel montante

Questo permette di spedire il display steso, risparmiando sul tempo di montaggio nel punto vendita e sui costi di trasporto.

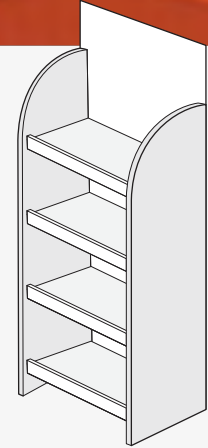

Altri colori su richiesta 



46

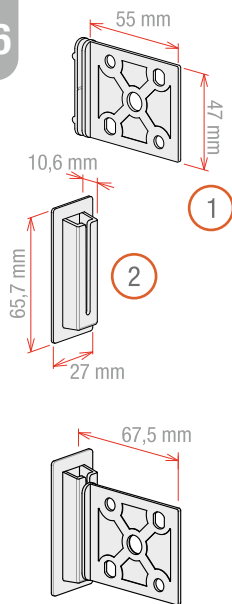

“FASTY” clip verticale per assemblaggio ripiani

A richiesta altri colori.

code	colore	pack
		pcs/box
321300WH	Bianco RAL9003	==
321300BK	Nero	==
321300TR	Trasparente	==
321300PL	PLA Trasparente	==
321300SC	Special color	==



Scegli il PLA

BIODEGRADABLE
selective waste

Utilizzate il PLA, un materiale
compostabile per un display
eco-friendly biodegradabile.

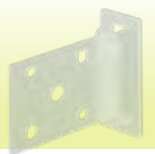

NEW



47

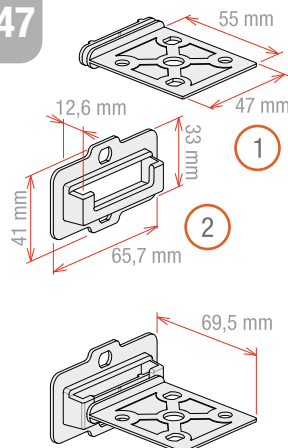

“FASTY” clip orizzontale per assemblaggio ripiani

A richiesta altri colori.

code	colore	pack
		pcs/box
321302WH	Bianco RAL9003	==
321302BK	Nero	==
321302TR	Trasparente	==
321302PLA	PLA Trasparente	==

Per assemblaggio espositori

Altri colori su richiesta



48

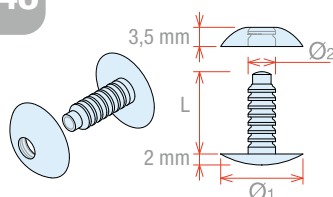

Rivetto a pressione / avvitamento - testa Ø 15 mm

code	L	Ø ₁	Ø ₂	per spessori	colore	pack
	mm	mm	mm	mm		pcs/box
714035	15	15	5,0	Fino a 8	Traslucido	==
714035WH	15	15	5,0	Fino a 8	Bianco	==
714036	22	15	5,0	Fino a 18	Traslucido	==
714036WH	22	15	5,0	Fino a 18	Bianco	==



49

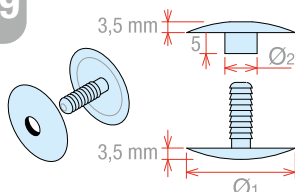

Rivetto a pressione - testa Ø 29 mm

code	Ø ₁	Ø ₂	per spessori	colore	pack
	mm	mm	mm		pcs/box
714030	29	8,5	Da 5 a 10	Trasparente	==
714032	29	8,5	Da 5 a 19	Trasparente	==
714034	29	8,5	Da 5 a 38	Trasparente	==



50

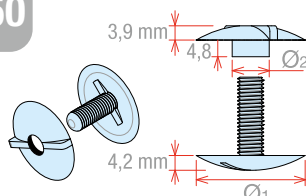

Rivetto a pressione / avvitamento - testa Ø 29 mm

code	Ø ₁	Ø ₂	per spessori	colore	pack
	mm	mm	mm		pcs/box
714040	29	8,5	Fino a 8	Trasparente	==
714042	29	8,5	Fino a 18	Trasparente	==



51

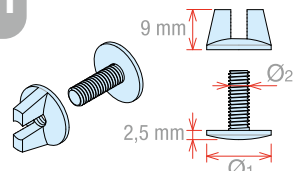

Vite a farfalla ad avvitamento

code	Ø ₁	Ø ₂	per spessori	colore	pack
	mm	mm	mm		pcs/box
714066	14	5,0	Fino a 10	Trasparente	100
714068	14	5,0	Fino a 22	Trasparente	100



52

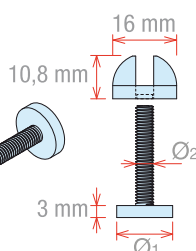

Vite a farfalla a pressione/avvitamento

code	Ø ₁	Ø ₂	per spessori	colore	pack
	mm	mm	mm		pcs/box
714052	13	4,6	Fino a 8	Trasparente	==
714054	13	4,6	Fino a 15	Trasparente	==
714056	13	4,6	Fino a 21	Trasparente	==



53

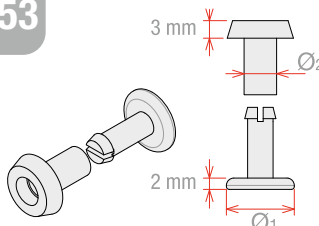

Rivetto a distanza fissa a pressione - testa Ø 12 mm

Disponibile anche in nero.

code	Ø ₁	Ø ₂	per spessori	colore	pack
	mm	mm	mm		pcs/box
714070	12	5,5	2,5	Bianco	1000
714072	12	5,5	5	Bianco	1000
714074	12	5,5	7,5	Bianco	1000
714076	12	5,5	10	Bianco	1000



54

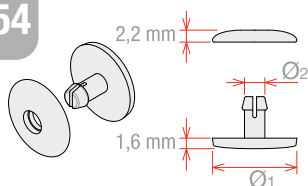

Rivetto slim a distanza fissa a pressione - testa Ø 12 mm

code	Ø ₁	Ø ₂	per spessori	colore	pack
	mm	mm	mm		pcs/box
714080	12	2,9	3	Bianco	==
714082	12	2,9	5	Bianco	==



55

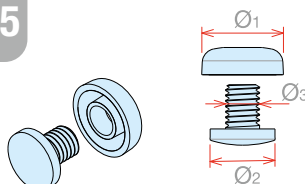

Rivetto ultra clear a pressione

code	Ø ₁	Ø ₂	Ø ₃	per spessori	colore	pack
	mm	mm	mm	mm		pcs/box
723065	12	9,3	4,7	Da 0,5 a 1,5	Trasparente	==
723066	12	9,3	4,7	Da 1,5 a 2,5	Trasparente	==

per assemblaggio espositori/campionari



56

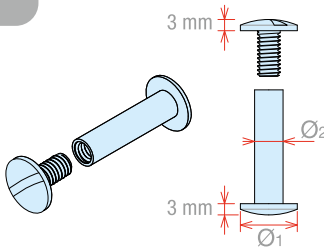

Vite per rilegatura a pressione/avvitamento in plastica

Disponibile in bianco e nero per spessori di mm 3,5/5/6/7/8/10/12/13/15/16/20/25/30/35/40/45/50/60/70/80/90.
Disponibile in trasparente per spessori di mm 3,5/5/10/15/20/25/30.

code	Ø ₁	Ø ₂	colore	pack
	mm	mm		pcs/box
714120WH	12	5,7	Bianco	1000
714120BK	12	5,7	Nero	1000
714120TR	12	5,7	Trasparente	1000



57

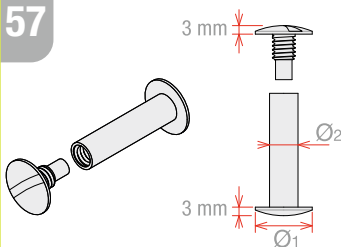

Vite per rilegatura nichelata

Disponibile in confezioni da 1000 pz. per spessori di mm 2/3,5/5/8/10/13/15/20/25/30/35/40. Disponibile in confezioni da 500 pz. per spessori di mm 45/50/55/60/65. Disponibile in confezioni da 250 pz. per spessori di mm 70/75/80/85/90/95/100.

code	Ø ₁	Ø ₂	colore
	mm	mm	
714130	10	5,0	Nichel



58

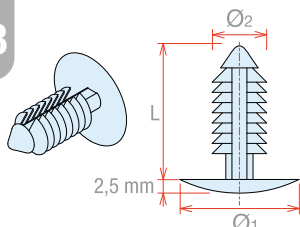

Clip ad albero a pressione

code	Ø ₁	Ø ₂	L	colore	pack
	mm	mm	mm		pcs/box
714180	18	6,0	Da 4,7 a 10,3	Trasparente	==
714182	18	6,0	Da 4,7 a 15,2	Trasparente	==



59

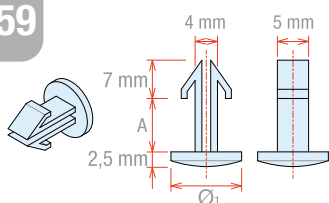

Clip a freccia a pressione

code	Ø ₁	A	colore	pack
	mm	mm		pcs/box
714204	12	4,0	Traslucido	==
714207	12	7,0	Traslucido	==
714210	12	10,0	Traslucido	==

Siamo specialisti nell'estrusione di profili.
Ampia gamma in stock per consegne veloci
Altri modelli disponibili su www.synco.it

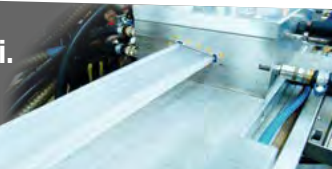

60 Portaprezzo con adesivo

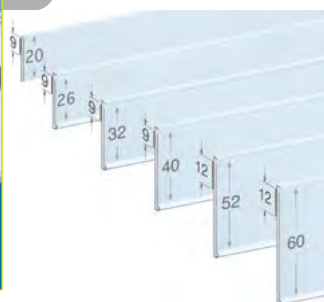

Profilo in PVC estruso con biadesivo sul retro.
A richiesta con banda magnetica o biadesivo schiuma.
Altre lunghezze su richiesta.



code	H.etichetta	lunghezza	H.adesivo	colore	pack
	mm	mm			pcs/box
DS00620TR1000	20	1000	9	Trasparente	100
DS00626TR1000	26	1000	9	Trasparente	100
DS00632TR1000	32	1000	9	Trasparente	100
DS00640TR1000	40	1000	9	Trasparente	100
DS00652TR1000	52	1000	12	Trasparente	100
DS00660TR1000	60	1000	12	Trasparente	100

61 Portaprezzo SLIM con adesivo

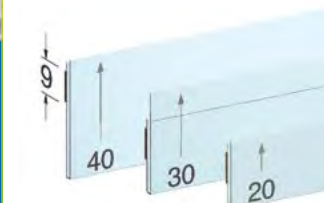

In PVC piegato antiriflesso. Si adatta alle leggere curvature di alcuni ripiani. Altre altezze e lunghezze su richiesta.

code	H.etichetta	H.retro	lunghezza	H.adesivo	colore	pack
	mm	mm	mm			pcs/box
DS01220TR1000	20	20	1000	9	Trasparente	100
DS01225TR1000	25	25	1000	9	Trasparente	100
DS0122624TR1000	26	24	1000	9	Trasparente	100
DS01230TR1000	30	20	1000	9	Trasparente	100
DS01230TR1330	30	20	1330	9	Trasparente	100
DS0124025TR1330	40	25	1330	9	Trasparente	100
DS0124036TR1330	40	36	1330	9	Trasparente	50
DS01240TR1000	40	40	1000	9	Trasparente	100
DS01250TR1000	50	30	1000	9	Trasparente	100
DS01260TR1000	60	59	1000	9	Trasparente	100

62 Portaprezzo universale con adesivo, inclinato 105°



Lato "A" standard 28 mm. Altre misure su richiesta, fino a 40 mm, per un ordine minimo di 4.000 m.
Adesivo schiuma su richiesta.



code	H.etichetta	A	lunghezza	H.adesivo	colore	pack
	mm	mm	mm			pcs/box
DS02432TR1000	32	28	1000	9	Trasparente	125
DS02432TR1330	32	28	1330	9	Trasparente	125
DS02440TR1000	40	28	1000	9	Trasparente	125
DS02440TR1330	40	28	1330	9	Trasparente	125

63 Portaprezzo universale con adesivo, angolo 90°



Lato "A" standard 28 mm. Altre misure su richiesta, fino a 40 mm, per un ordine minimo di 4.000 m.
Adesivo schiuma su richiesta.



code	H.etichetta	A	lunghezza	H.adesivo	colore	pack
	mm	mm	mm			pcs/box
DS03032TR1000	32	28	1000	9	Trasparente	125
DS03032TR1330	32	28	1330	9	Trasparente	125
DS03040TR1000	40	28	1000	9	Trasparente	125
DS03040TR1330	40	28	1330	9	Trasparente	125

Altri colori su richiesta



64 Profilo per category in PVC antiriflesso - INSERIMENTO FRONTALE

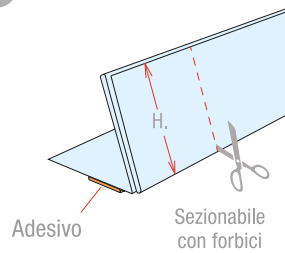

Da posizionare su ripiani o cassettiere di mobili. Consigliato per inserimento prezzi (cambio veloce) e/o category. Altre altezze e lunghezze su richiesta.

code	H.etichetta	lunghezza	colore	pack
	mm	mm		pcs/box
DS18320ANF1000	20	1000	Trasparente	100



65 Binario adesivo con frontale a tasca arrotondato per etichetta H. 32 mm

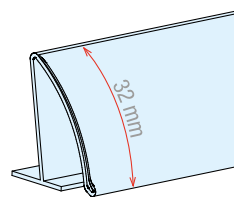

Profilo adesivo per etichette H. 32 mm. Indicato per comunicazione di category o brand. Altre lunghezze a richiesta.



code	H.etichetta	lunghezza	colore	pack
	mm	mm		pcs/box
DRRAD32NRTR1330	32	1330	Trasparente	50



66 Profilo BASCULANTE H. 32/40 mm doppia comunicazione per ripiani in vetro

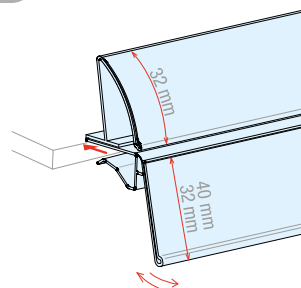

Adatto per ripiani in vetro con spessore da 3 a 13 mm. Inserimento etichetta frontale. Profilo accoppiato. Disponibile con portaprezzo inferiore per etichetta H 32 o 40 mm.



code	H.etichetta	lunghezza	spessore	colore	pack
	mm	mm	mm		pcs/box
DS182NORA1000	32 / 32	1000	Da 3 a 13	Trasparente	20
DS182NORA1330	32 / 32	1330	Da 3 a 13	Trasparente	20
DS193NORA1000	32 / 40	1000	Da 3 a 13	Trasparente	15
DS193NORA1330	32 / 40	1330	Da 3 a 13	Trasparente	15



67 Portaprezzo H.18 mm per ripiani in vetro

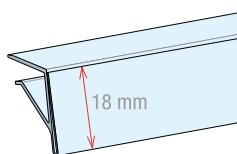

Adatto per ripiani in vetro con spessore da 6 a 10 mm. Inserimento etichetta frontale. Altre lunghezze su richiesta.

code	H.etichetta	lunghezza	spessore	colore	pack
	mm	mm	mm		pcs/box
DS19118TR1000	18	1000	Da 6 a 10	Trasparente	100



68 Portaprezzo BASCULANTE per ripiani in vetro

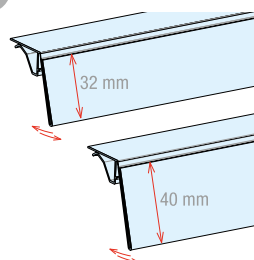

Adatto per ripiani in vetro con spessore da 3 a 13 mm. Inserimento etichetta frontale. Altre altezze e lunghezze su richiesta.



code	H.etichetta	lunghezza	spessore	colore	pack
	mm	mm	mm		pcs/box
DS19332TR1000	32	1000	Da 3 a 13	Trasparente	60
DS19340TR1000	40	1000	Da 3 a 13	Trasparente	50



69 Supporto BASCULANTE adesivo a pinza per evidenziatori

Supporto con gomma antiscivolo.

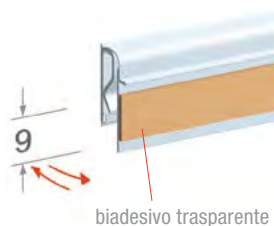

code	lunghezza	H. adesivo	colore	pack
	mm	mm		pcs/box
DS19800TR2000	2000	9,0	Trasparente	125

Altre lunghezze su richiesta.

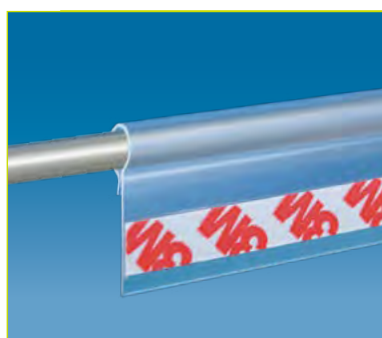

70 Profilo adesivo per filo metallico

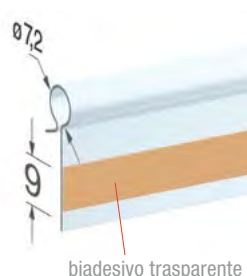

code	lunghezza	per Ø max	H. adesivo	colore	pack
	mm	mm	mm		pcs/box
LHH50BARTR2660	2660	6,0	9,0	Trasparente	100

Altre lunghezze su richiesta.

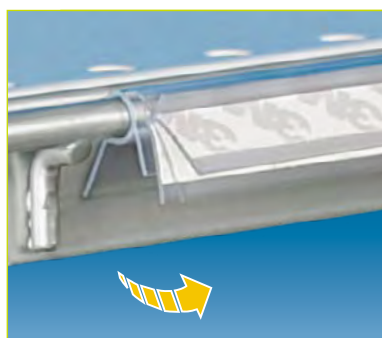

71 Profilo a pinza BASCULANTE adesivo per filo Ø 6 mm

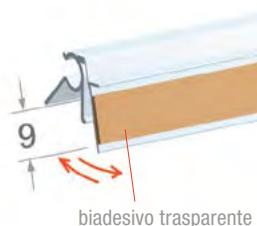

code	lunghezza	Ø	H. adesivo	colore	pack
	mm	mm	mm		pcs/box
DS13200TR2660	2660	6,0	9,0	Trasparente	100

Altre lunghezze su richiesta.



72 Supporto adesivo per ripiani spessore da 3 a 10 mm

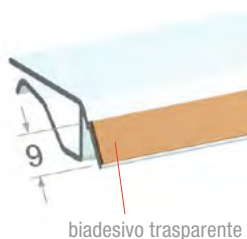

code	lunghezza	per spessori	colore	pack
	mm	mm		pcs/box
DS18600TR1000	1000	da 3 a 10	Trasparente	60

Altre lunghezze su richiesta.



73 Supporto BASCULANTE adesivo per ripiani spessore da 3 a 10 mm

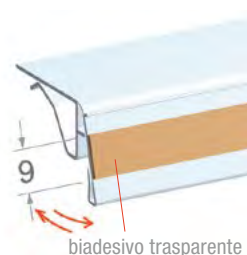

code	lunghezza	per spessori	colore	pack
	mm	mm		pcs/box
DS17400TR1000	1000	da 3 a 10	Trasparente	80

Altre lunghezze su richiesta.

Ampia gamma disponibile su www.synco.it

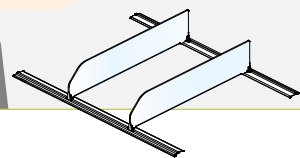

74 Separatore SPEZZABILE H.50 mm - senza stopper

In PET, spezzabile a mano ogni 25 mm. Attacco ai binari con "T" standard (6 mm). Clip standard frontale e clip slim sul retro.

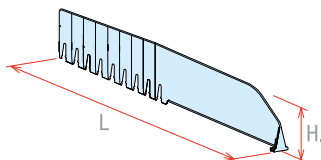

code	spezzabile (L) mm	H. mm	colore	pack pcs/box
DVBRKWS050380	da 380 a 180	50	Trasparente	12
DVBRKWS050480	da 480 a 280	50	Trasparente	12
DVBRKWS050580	da 580 a 380	50	Trasparente	12



75 Separatore FOCUS H.50 mm con 1 clip standard e 1 slim - senza stopper

In PET, con attacco ai binari con "T" standard (6 mm). Clip standard frontale e clip slim sul retro.

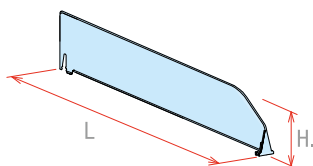

code	L mm	H. mm	colore	pack pcs/box
DVMICWS050280	280	50	Trasparente	12
DVMICWS050380	380	50	Trasparente	12
DVMICWS050480	480	50	Trasparente	12

76 Mini-binario trasparente adesivo

Profilo adesivo indicato in particolare per un impatto minimal. Con "T" standard (6 mm) per attacco separatori.

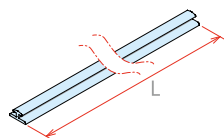

code	L mm	colore	pack pcs/box
DMRAD00TR1000	1000	Trasparente	100

Altre lunghezze su richiesta.

77 Binario con frontale a tasca arrotondato per etichetta H. 32 mm - adesivo

Ideale per comunicazione di category o di brand. Con "T" standard (6 mm) per attacco separatori.

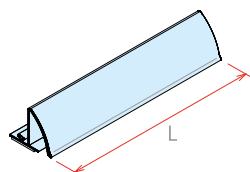

code	L mm	colore	pack pcs/box
DRRAD32TR1000	1000	Trasparente	50

Altre lunghezze su richiesta.

78 Avanzatore SLIM a molla senza frontalino

Con sistema di facile aggancio-sgancio. Su richiesta **CON BIADESIVO** per applicazione senza binari.

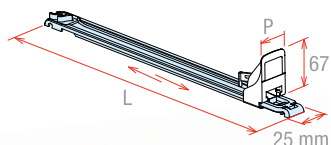

code	L mm	P. mm	forza molla Newton	colore	pack pcs/box
DVPUSSL01F280	280	29	3	Trasparente	10
DVPUSSL01F380	380	29	3	Trasparente	10
DVPUSSL01F480	480	29	3	Trasparente	10
DVPUSSL02F280	280	29	6	Trasparente	10
DVPUSSL02F380	380	29	6	Trasparente	10
DVPUSSL02F480	480	29	6	Trasparente	10
DVPUSSL03F280	280	29	9	Trasparente	10
DVPUSSL03F380	380	29	9	Trasparente	10
DVPUSSL03F480	480	29	9	Trasparente	10

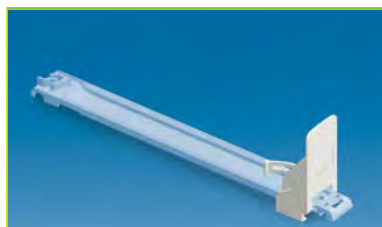

Altri modelli disponibili su www.synco.it

Elevato grip
Magnete in ferrite ad alta tenuta



Se leggermente urtato,
ritorna in posizione

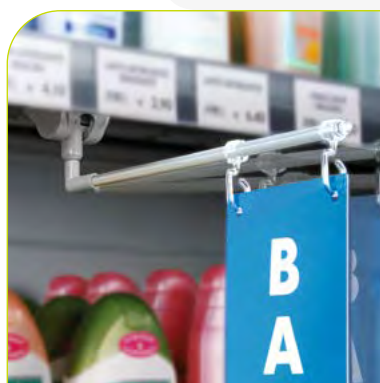

79 “SWING III” basculante magnetico

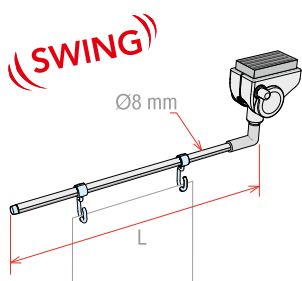

Ergonomico, estetico e versatile.
Da posizionare sotto, sopra lo scaffale ed a parete.
Asta inclinabile in alluminio e ganci trasparenti.
2 scanalature sull'asta evitano la rotazione accidentale del gancio.
Se urtata, l'asta torna nella posizione iniziale. A richiesta asta su misura.

code	L	per pesi fino a	colore (parti in plastica)	pack
	mm	g		pcs/box
841208BK	260	250	Nero	10
841208	260	250	Grigio	10



80 “SHOCK ABSORBER” magnetico - attacco sotto al ripiano

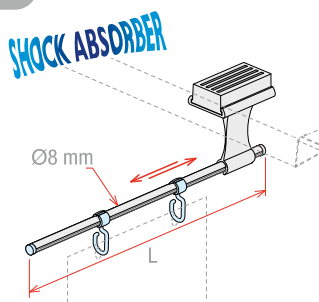

Economico, da posizionare sopra o sotto il ripiano.
Asta in alluminio regolabile in profondità e ganci trasparenti.
2 scanalature sull'asta evitano la rotazione accidentale del gancio.
Se urtata leggermente, l'asta torna nella posizione iniziale.
A richiesta, per quantità, asta su misura.

code	L	per pesi fino a	colore (parti in plastica)	pack
	mm	g		pcs/box
841260BK	250	120	Nero	10
841260	250	120	Grigio	10



81 “SHOCK ABSORBER” magnetico - attacco verticale

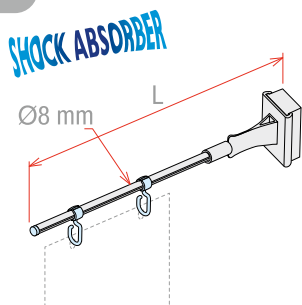

Applicabile su barre di forza, montanti di rack, ecc.
2 scanalature sull'asta evitano la rotazione accidentale del gancio.
Se urtata leggermente, l'asta torna nella posizione iniziale.
A richiesta, per quantità, asta su misura.

code	L	per pesi fino a	colore	pack
	mm	g		pcs/box
841280	320	100	Grigio	10

Altri modelli disponibili su www.synco.it

NEW



82 Porta banner magnetico

Da posizionare sotto, sopra lo scaffale ed a parete. Asta inclinabile.

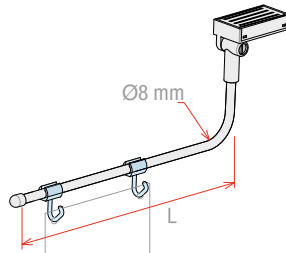

code	L	per pesi fino a	colore	pack
	mm	g		pcs/box
841207	300	250	Bianco	10



83 Porta banner magnetico - attacco sopra al ripiano

Asta in alluminio regolabile in profondità e ganci trasparenti. 2 scanalature sull'asta evitano la rotazione accidentale del gancio. A richiesta, per quantità, asta su misura.

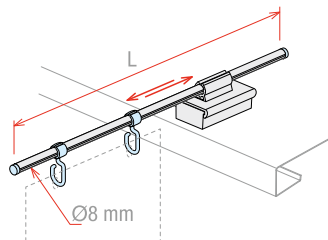

code	L	per pesi fino a	colore	pack
	mm	g		pcs/box
841250	250	300	Grigio	10



84 Telescopico magnetico - attacco verticale

Applicabile su barre di forza, montanti di rack, ecc. Composto da aste in alluminio Ø13 e 10 mm. A richiesta, per quantità, asta su misura.

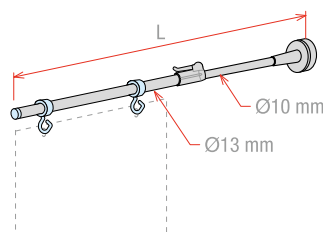

code	estensibile	per pesi fino a	colore	pack
	mm	g		pcs/box
841040	da 380 a 630	220	Grigio	10

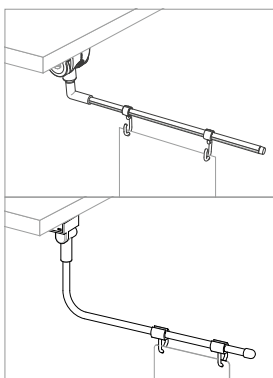

Sotto al ripiano

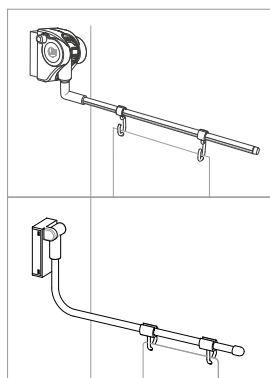

A parete
(su montanti, ecc.)

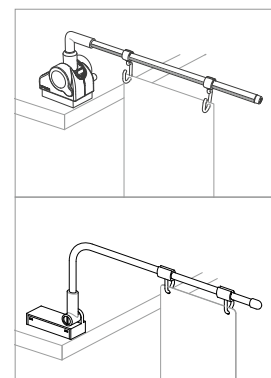

Sopra al ripiano
(ruotando i ganci)



85 Twister in alluminio con 2 adesivi

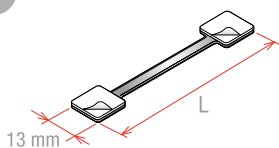

Si può torcere per evidenziare in modo ottimale il messaggio.

code	L.	materiale	pack
	mm		pcs/box
792571	75	Alluminio	100



86 Megatwister in alluminio con 2 adesivi

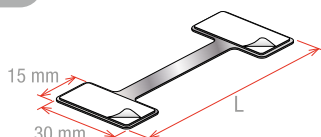

Si può torcere per evidenziare in modo ottimale il messaggio.

code	L.	materiale	pack
	mm		pcs/box
792574	75	Alluminio	100



87 Porta stopper oscillante con 2 adesivi

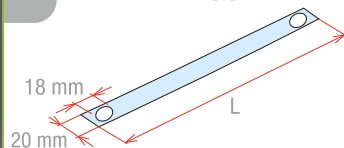

Per esporre un messaggio in modo accattivante.

code	L.	materiale	pack
	mm		pcs/box
170017	180	PVC trasparente	100



88 Distanziale oscillante adesivo

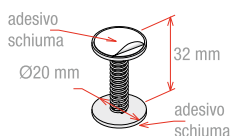

Molla in ferro da 30 mm con due bottoni in plastica bianca Ø 20 mm con applicato bollino adesivo schiuma.

code	materiale	pack
		pcs/box
714020	Ferro nichelato / Plastica bianca	100



89 Clip porta messaggio per cursori scanner

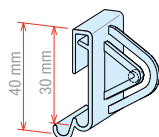

Per messaggi a bandiera con sistema di bloccaggio con foro.

code	colore	pack
		pcs/box
262012	Traslucido	100



90 Porta stop a bandiera per profili porta etichette elettroniche

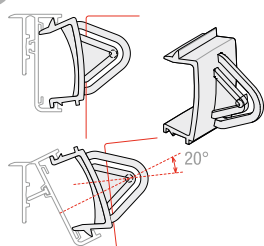

Per messaggi a bandiera con sistema di bloccaggio con foro, per profili porta etichette elettroniche. Con 2 posizioni: verticale o inclinato a 20°.

code	colore	pack
		pcs/box
262017	Bianco opalino	100

Ampia gamma di accessori per etichette elettroniche su www.synco.it



91 Clip gripper per profilo scanner H.40 mm

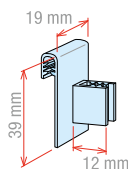

Per messaggi a bandiera. Adatto anche ai frontalini da scaffale ad "L" H. min. 40 mm o ad altri spessori.

code	colore	pack
		pcs/box
797193	Trasparente	100



Caratterizzate brand o category con le clip a spirale per ripiani: uno strumento versatile per l'evidenziazione di messaggi in cartone o in plastica.



92 Clip universale per ripiani con frontale liscio

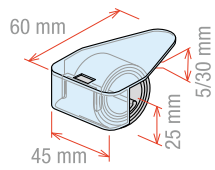

code	per spessori	colore	pack
	mm		pcs/box
744008F	Da 5 a 30	Trasparente	20

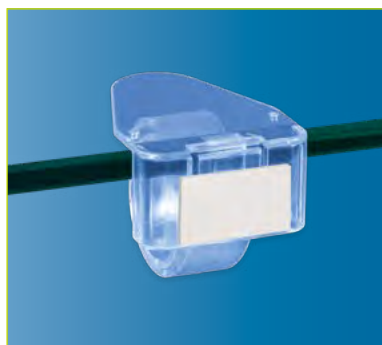

93 Clip universale per ripiani con bollino adesivo

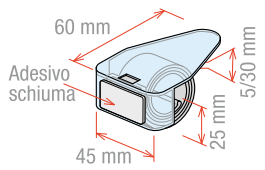

code	per spessori	colore	pack
	mm		pcs/box
744008FAD	Da 5 a 30	Trasparente	20



94 Clip universale per ripiani con gripper

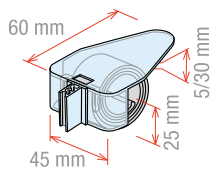

code	gripper	per spessori	colore	pack
	mm	mm		pcs/box
744008GTR	Fino a 2	Da 5 a 30	Trasparente	20

Bandierine con tubi Ø 7 mm



95

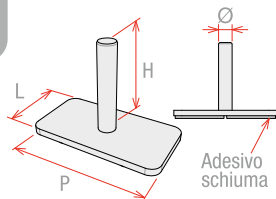

Supporto diritto adesivo per tubo Ø 7 mm

Con adesivo schiuma, si attacca a superfici orizzontali o verticali per creare bandierine. Da utilizzare con i tubi code 841312/841312F

code	Ø	LxP.	H.	colore	pack
	mm	mm	mm		pcs/box
841302	5,0	38x20	25	Bianco	==



96

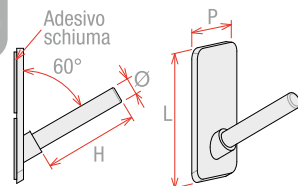

Supporto obliquo adesivo per tubo Ø 7 mm

Con adesivo schiuma, si attacca a superfici orizzontali o verticali per creare bandierine. Da utilizzare con i tubi code 841312/841312F

code	Ø	LxP.	H.	colore	pack
	mm	mm	mm		pcs/box
841304	5,0	40x20	28	Bianco	==



97

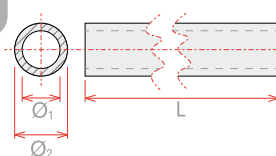

Tubo Ø 7 mm per bandierina

In plastica bianca. Taglio su misura su richiesta.

code	Ø1	Ø2	L.	colore	pack
	mm	mm	mm		pcs/box
841312	5,0	7,0	1500	Bianco	==



98

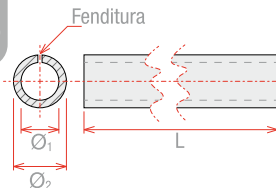

Tubo con fenditura Ø 7 mm per bandierina

In plastica bianca. Il messaggio, graffettato per garantire una tenuta ottimale, si inserisce nella fenditura. Taglio su misura su richiesta.

code	Ø1	Ø2	L.	colore	pack
	mm	mm	mm		pcs/box
841312F	5,0	7,0	1500	Bianco	==



99

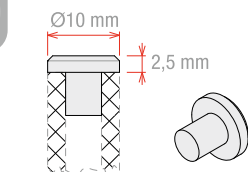

Tappo interno per tubo Ø 7 mm

In plastica bianca.

code	Ø	colore	pack
	mm		pcs/box
841320	10,0	Bianco	==

Tubi Ø 25 mm



100

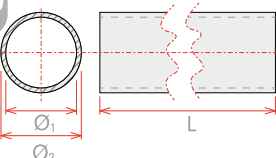

Tubo Ø 25 mm

In plastica bianca. Taglio su misura su richiesta.

code	Ø1	Ø2	L.	colore	pack
	mm	mm	mm		pcs/box
84132125	22,0	25,0	1000	Bianco	==



101

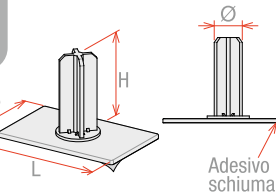

Supporto adesivo per tubo Ø 25 mm

Con adesivo schiuma. Da utilizzare con i tubi code 84132125

code	Ø	LxP.	H.	colore	pack
	mm	mm	mm		pcs/box
B84132125	25,0	80x50	52	Bianco	==

I gripper: con alette interne in gomma per una tenuta ottimale



102

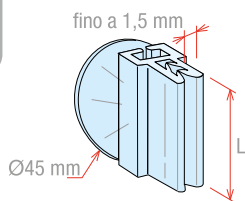

Gripper con ventosa Ø 45 mm

code	Ø	L	per spessori	colore	pack
	mm	mm	mm		pcs/box
797120	45	45	Fino a 1,5	Trasparente	100



103

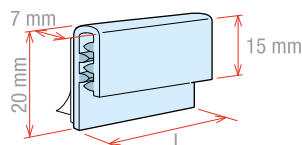

Gripper a pinza frontale - adesivo schiuma

code	L	per spessori	adesivo	colore	pack
	mm	mm			pcs/box
797108	25	Fino a 1,6	Schiuma	Trasparente	100
797109	76	Fino a 1,6	Schiuma	Trasparente	100
797110	152	Fino a 1,6	Schiuma	Trasparente	100
797112	25	Da 1,6 a 3	Schiuma	Trasparente	100



104

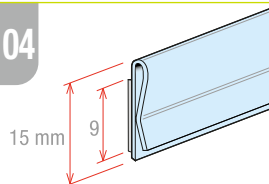

Guida per pannelli adesiva

code	L	colore	pack
	mm		pcs/box
690402	2000	Trasparente	100

Altre lunghezze su richiesta.



105

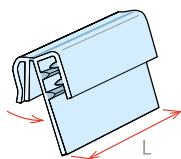

Gripper basculante frontale per cursore scanner

code	L	per spessori	colore	pack
	mm	mm		pcs/box
797195	25	Da 1,5 a 2	Trasparente	100
797197	76	Da 1,5 a 2	Trasparente	100



106

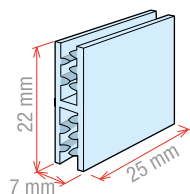

Gripper di giunzione ad H

code	L	per spessori	colore	pack
	mm	mm		pcs/box
797153	25	Fino a 1,6	Trasparente	100



107

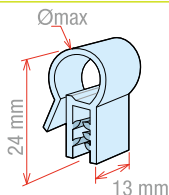

Gripper porta messaggio ad 1 gancio

code	Ø max	per spessori	colore	pack
	mm	mm		pcs/box
797180	10	Fino a 2	Trasparente	20



108

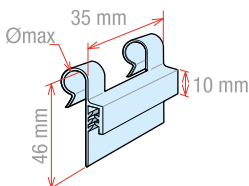

Gripper porta messaggio a 2 ganci

code	Ø max	per spessori	colore	pack
	mm	mm		pcs/box
797182	9	Fino a 1,5	Trasparente	100

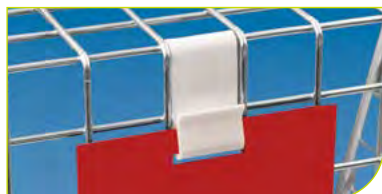

109

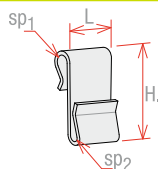

Doppio gancio porta messaggi

code	sp ₁	sp ₂	colore	pack
	mm	mm		pcs/box
111810	Fino a 6	Fino a 3	Bianco	100

I gripper: con alette interne in gomma per una tenuta ottimale



110

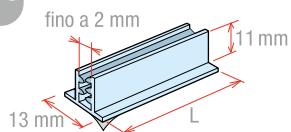

Gripper adesivo a "T" - base 13 mm

Per uso orizzontale o verticale.

code	L	per spessori	adesivo	colore	pack
	mm	mm			pcs/box
797147	25	Fino a 2	Schiuma	Trasparente	100
797148	76	Fino a 2	Schiuma	Trasparente	100



111

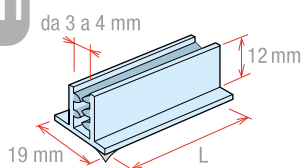

Gripper adesivo a "T" - base 19 mm

Per uso orizzontale o verticale.

code	L	per spessori	adesivo	colore	pack
	mm	mm			pcs/box
797126	25	Da 3 a 4	Schiuma	Trasparente	100
797127	75	Da 3 a 4	Schiuma	Trasparente	100
797128	152	Da 3 a 4	Schiuma	Trasparente	100



112

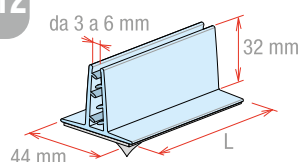

Gripper adesivo a "T" - base 44 mm

Per alti spessori. Per uso orizzontale o verticale.

code	L	per spessori	adesivo	colore	pack
	mm	mm			pcs/box
797145	76	Da 3 a 6	Schiuma	Trasparente	40

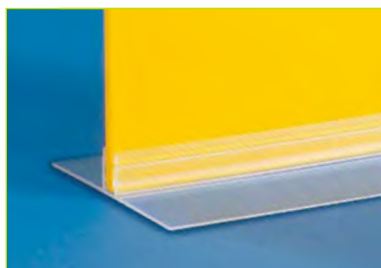

113

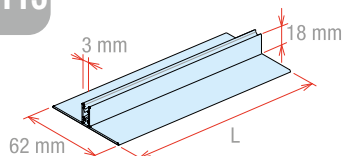

Gripper a "T" - base 62 mm

In stock barre lunghezza 1330 mm.

code	L	per spessori	colore	pack
	mm	mm		pcs/box
630002	su richiesta	3	Trasparente	40



114

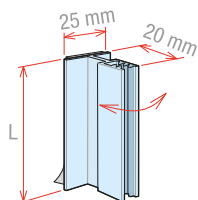

Gripper adesivo a "T" basculante - base 25 mm

Se urtato, torna nella posizione iniziale. Per uso verticale.

code	L	per spessori	adesivo	colore	pack
	mm	mm			pcs/box
797168	25	Fino a 1,6	Schiuma	Trasparente	100
797169	75	Fino a 1,6	Schiuma	Trasparente	100
797170	76	Fino a 3	Schiuma	Trasparente	100



115

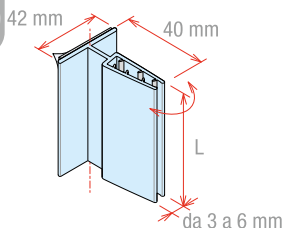

Gripper adesivo a "T" basculante - base 42 mm

Se urtato, torna nella posizione iniziale. Per uso verticale.

code	L	per spessori	adesivo	colore	pack
	mm	mm			pcs/box
797172	75	Da 3 a 6	Schiuma	Trasparente	50

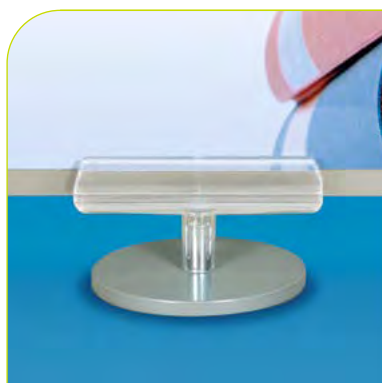

116

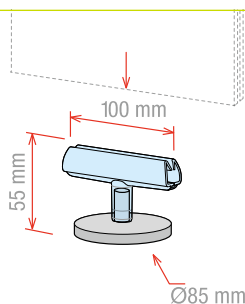

Base in acciaio tonda Ø 85 mm con pinza ELITE

Per comunicazioni di spessore da 1 a 5 mm.
Disponibile tasca porta messaggio A4 verticale in PETG da 1,5 mm (code 242068), venduta a parte (altri formati a richiesta).

code	H.	Ø	colore	pack
	mm	mm		pcs/box
842257	55	85	Grigio RAL9006	10



117

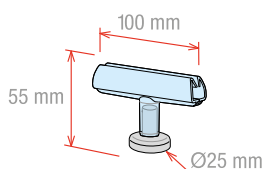

Base magnetica con supporto a pinza ELITE

Per comunicazioni di spessore da 1 a 5 mm.
Disponibile tasca porta messaggio A4 verticale in PETG da 1,5 mm (code 242068), venduta a parte (altri formati a richiesta).

code	H.	forza magnete	colore	pack
	mm	kg		pcs/box
772157	55	13	Trasparente	10

NEW



118

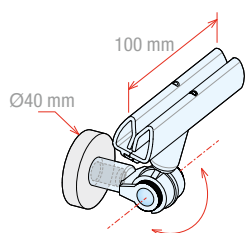

Base magnetica con snodo e supporto a pinza ELITE

Ideale per comunicazioni su pareti metalliche.
Per comunicazioni di spessore da 1 a 5 mm.
Disponibile tasca porta messaggio A4 verticale in PETG da 1,5 mm (code 242068), venduta a parte (altri formati a richiesta).

code	forza magnete	colore	pack
	kg		pcs/box
772068	13	Trasparente	10



119

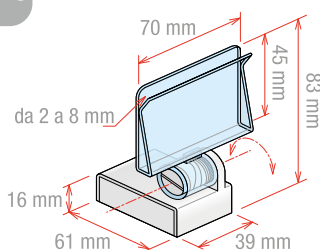

Piede magnetico e clip inclinabile porta pannelli

code	L	per spessori	colore	pack
	mm	mm		pcs/box
243080	70	Da 2 a 8	Trasparente	20



120 Porta messaggio adesivo

Con biadesivo schiuma. Magnetico a richiesta.

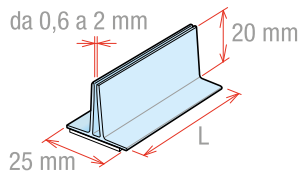

code	L	per spessori	adesivo	colore	pack
	mm	mm			pcs/box
630050	50	Da 0,6 a 2	Schiuma	Trasparente	100
630075	75	Da 0,6 a 2	Schiuma	Trasparente	100
630100	100	Da 0,6 a 2	Schiuma	Trasparente	100
630150	150	Da 0,6 a 2	Schiuma	Trasparente	100



121 Porta messaggio non adesivo

Adesivo o magnetico a richiesta.

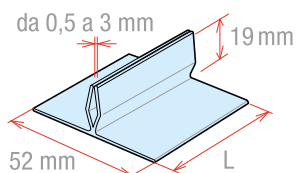

code	L	per spessori	colore	pack
	mm	mm		pcs/box
631050	50	Da 0,5 a 3	Trasparente	100
631075	75	Da 0,5 a 3	Trasparente	100
631100	100	Da 0,5 a 3	Trasparente	100
631150	150	Da 0,5 a 3	Trasparente	100



122 Clip cristal

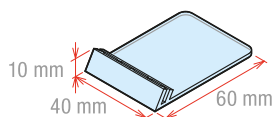

code	per spessori	colore	pack
	mm		pcs/box
242070	Fino a 0,5 mm	Trasparente	100



123 Porta messaggio trasparente adesivo

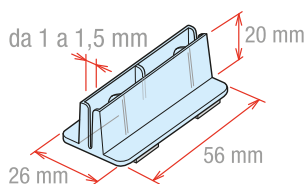

code	per spessori	adesivo	colore	pack
	mm			pcs/box
792584	Da 1 a 1,5	Schiuma	Trasparente	100



124 Porta messaggio a doppia pinza piccola senza asta

Porta messaggio snodabile a doppia pinza piccola (22 mm).

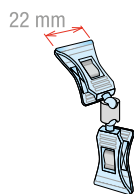

code	asta	colore	pack
			pcs/box
SPSC000SC	Senza asta	Trasparente	10



125 Porta messaggio largo 25 mm con pinza piccola

Porta messaggio snodabile con pinza piccola (22 mm).

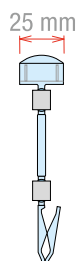

code	asta	colore	pack
	mm		pcs/box
SP25000SC	Senza asta	Trasparente	10
SP25050SC	50	Trasparente	10
SP25100SC	100	Trasparente	10



126 Porta messaggio largo 50 mm con pinza media

Porta messaggio snodabile con pinza media.

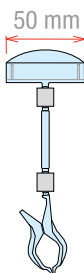

code	asta	colore	pack
	mm		pcs/box
SP50000ST	Senza asta	Trasparente	10
SP50050ST	50	Trasparente	10
SP50100ST	100	Trasparente	10



127 Porta messaggio da 80 mm con pinza media

Porta messaggio snodabile con pinza media.

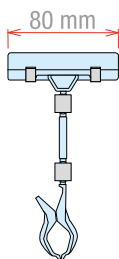

code	asta	colore	pack
	mm		pcs/box
SP80000ST	Senza asta	Trasparente	10
SP80050ST	50	Trasparente	10
SP80100ST	100	Trasparente	10

Ampia gamma disponibile su www.synco.it



128 Spillo inox a spirale

code	H.	materiale	pack
	mm		pcs/box
741039	75	Acciaio inox	50

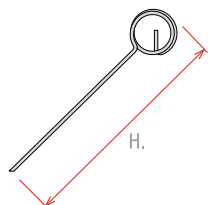

129 Spillo plastica bianco con doppia punta attacco a snodo

code	colore	pack
		pcs/box
741004	Bianco	20
741005	Nero	20

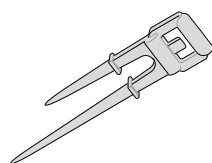

130 Clip a pinza porta messaggio con snodo

code	L	per spessori	colore	pack
	mm	mm		pcs/box
744166	20	Fino a 0,7 mm	Bianco	20
744175	20	Fino a 0,7 mm	Nero	20
744166TR	20	Fino a 0,7 mm	Trasparente	20

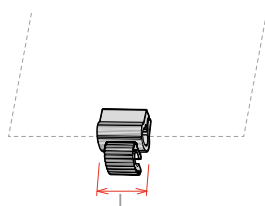

131 Piantanina trasparente con porta messaggio inclinabile 55 mm

Piantana fissa con porta messaggio con snodo.

code	H.	colore	pack
	mm		pcs/box
SP55130PF	155	Trasparente	20

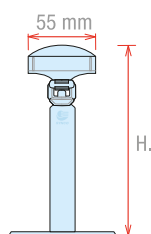



Altri colori su richiesta

Ampia gamma disponibile su www.synco.it



132 Profilo poster perforato

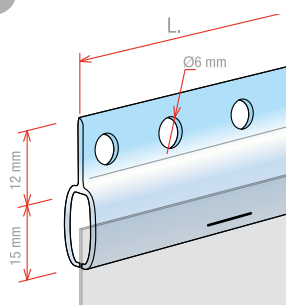

Trasparente, il poster viene inserito lateralmente a scorrimento e tenuto tramite punti metallici.

code	L.	colore	pack
	mm		pcs/box
851026	500	Trasparente	100
851028	700	Trasparente	100
851030	1000	Trasparente	100

Altre lunghezze o colori su richiesta.



133 Profilo poster a pinza piccolo - sistema a scatto

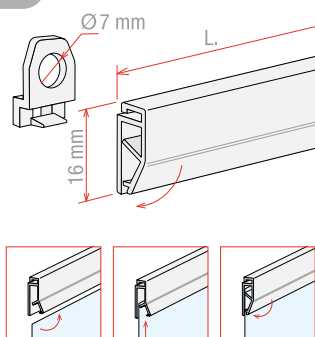

Specifico gancio per la sospensione venduto a parte.

code	descrizione	L.	colore	pack
		mm		pcs/box
852000	Profilo poster	500	Bianco	100
852000TR	Profilo poster	500	Trasparente	100
852002	Profilo poster	700	Bianco	100
852002TR	Profilo poster	700	Trasparente	100
852004	Profilo poster	1000	Bianco	100
852004TR	Profilo poster	1000	Trasparente	100
852010	Gancio	==	Bianco	200
852010TR	Gancio	==	Trasparente	200

Altre lunghezze o colori su richiesta.



134 Profilo poster a pinza grande - sistema a scatto

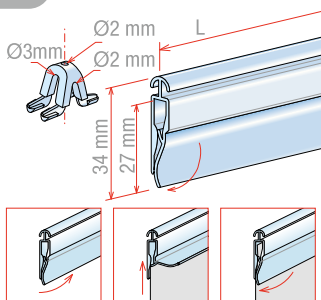

Specifico gancio per la sospensione venduto a parte.

code	descrizione	L.	colore	pack
		mm		pcs/box
713050	Profilo poster	500	Trasparente	100
713070	Profilo poster	700	Trasparente	100
713100	Profilo poster	1000	Trasparente	100
852011	Gancio	==	Trasparente	200

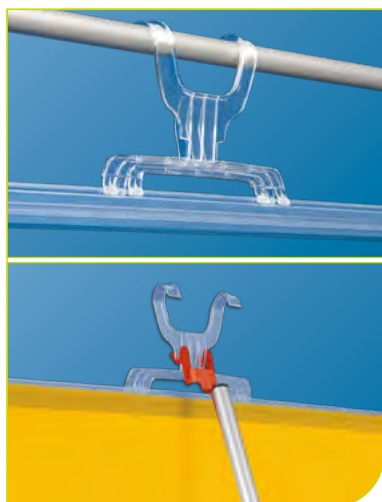

135 Supporto di sospensione KELA per profilo a pinza grande

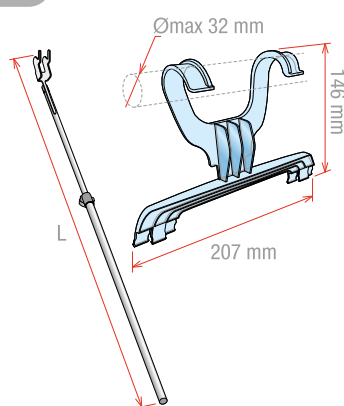

Da utilizzare con profilo poster a pinza grande.

code	descrizione	colore	pack
			pcs/box
713000	Kela	Trasparente	10
713010	Asta telescopica per Kela	Grigio	1



Porta manifesti e fogli leggeri
(con cilindretti autobloccanti)

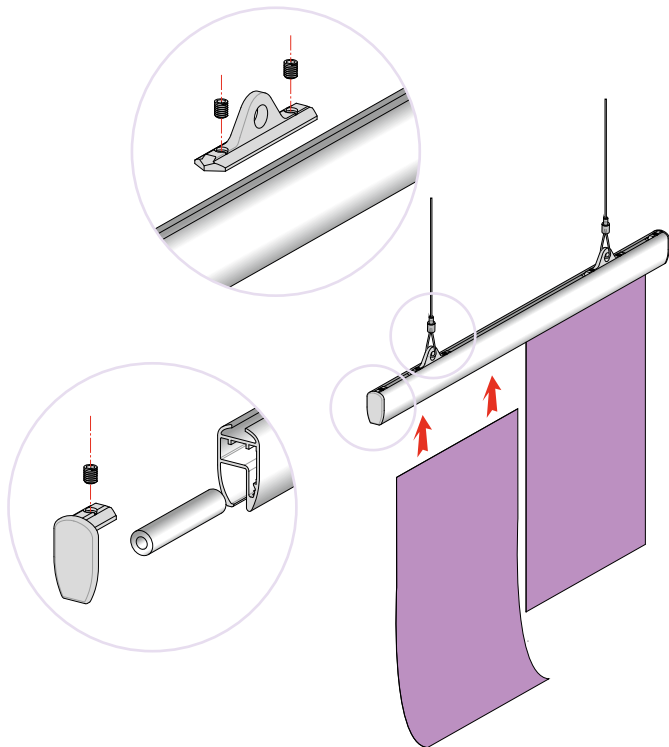

Porta bandone telato

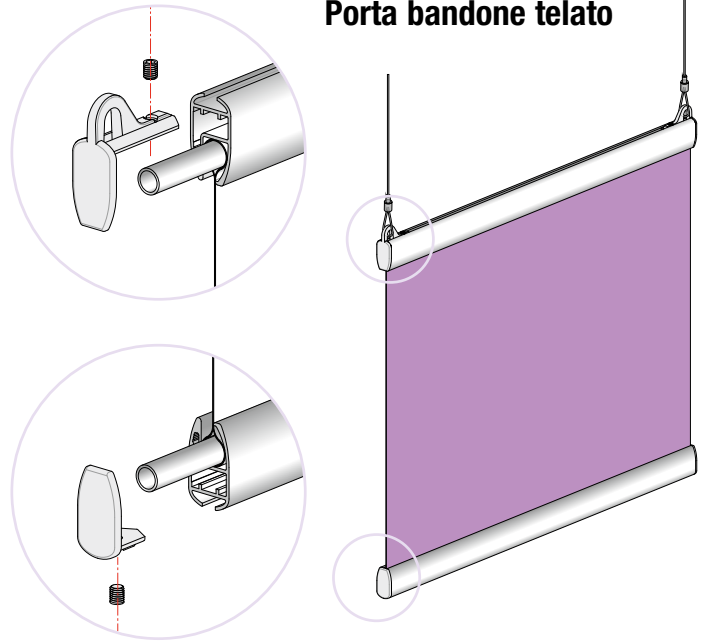

Struttura perimetrale
porta manifesti

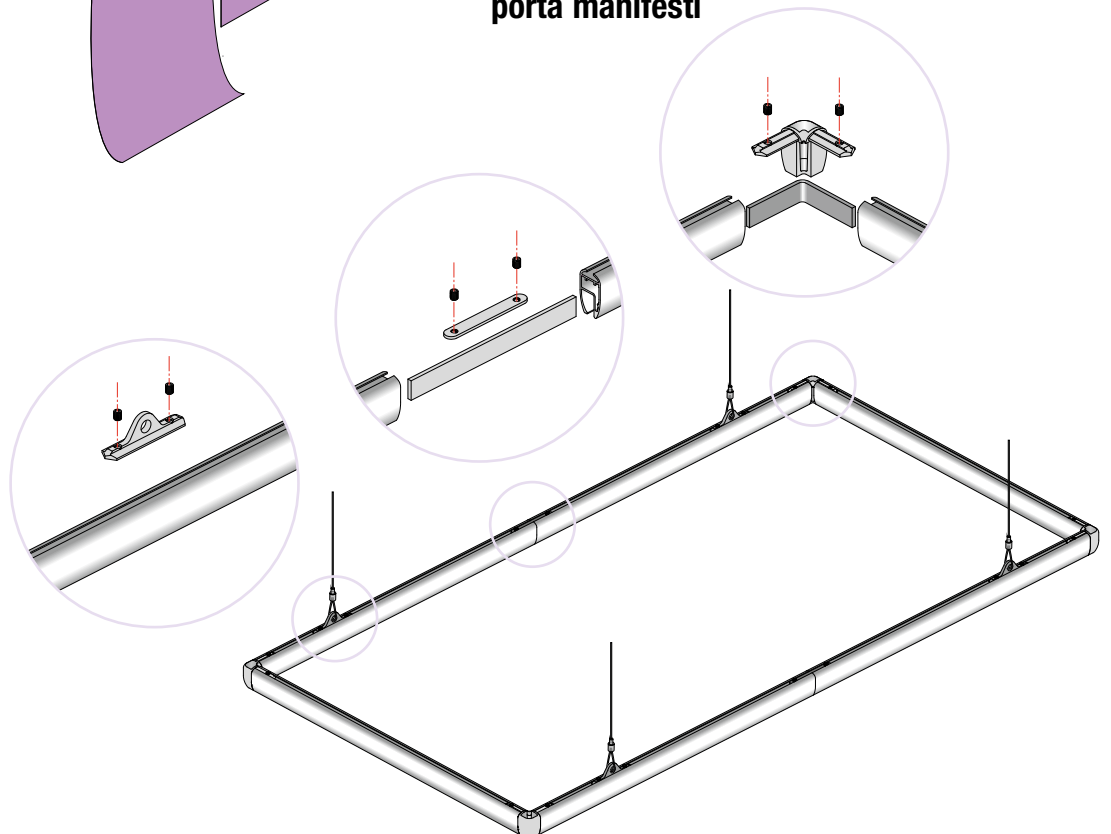

NEW

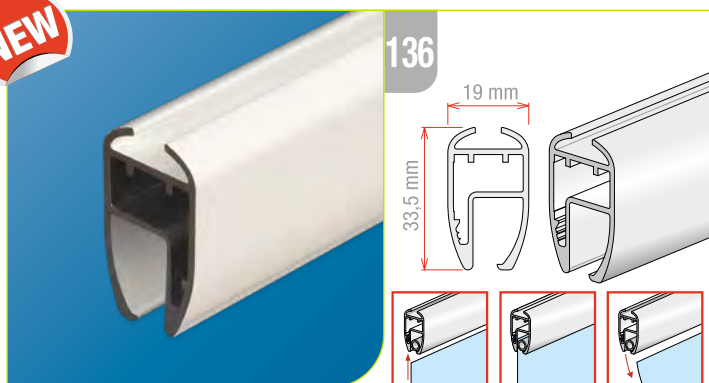

Barra STYLEBAR - solo barra

code	L.	colore	pack
	mm		pcs/box
711802	3050	Bianco RAL9003	5
711809	3050	Special colour	5

Accessori

137 Tappo di chiusura



Tappo di chiusura in plastica, completo di vite.

code	colore	pack
		pcs/box
711832	Bianco	20

138 Tappo di chiusura con foro per sospensione



Tappo di chiusura in plastica, completo di vite.

code	colore	pack
		pcs/box
711830	Bianco	20

139 Gancio per la sospensione

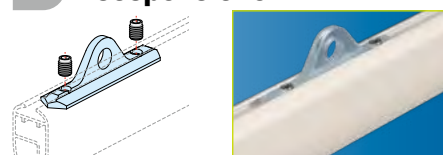

Gancio in plastica, completo di viti di fissaggio.

code	colore	pack
		pcs/box
711023TR	Trasparente	20

140 Kit giunto diritto

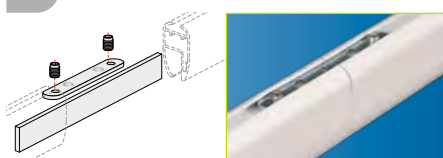

Kit in metallo, completo di viti di fissaggio.

code	pack
	pcs/box
711106	10

141 Kit giunto diritto con foro sospensione

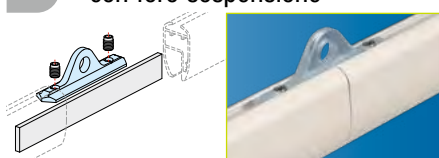

Gancio in plastica con barretta in metallo, completo di viti di fissaggio.

code	colore	pack
		pcs/box
711109	Trasparente	10

142 Kit giunto a 90°

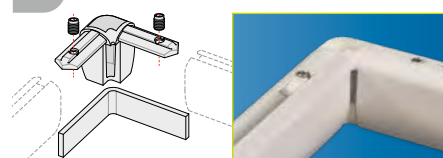

Giunto in plastica con barretta in metallo, completo di viti di fissaggio.

code	colore	pack
		pcs/box
711823	Bianco	10

143 Cilindretto per manifesti

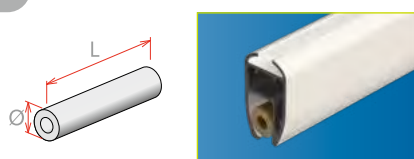

Cilindretto per manifesti in plastica.

code	Ø	L.	pack
	mm	mm	pcs/box
915037	10	50	10

144 Tubo per banner a tasche

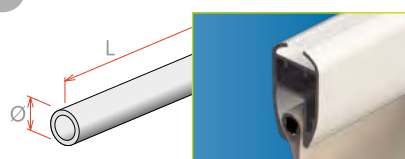

In alluminio.

code	Ø	L.	pack
	mm	mm	pcs/box
710508	8	Su misura	10



Sistema a molla anti-fuoriuscita:
Una volta inseriti,
i tubi ed i giunti rimangono bloccati



145

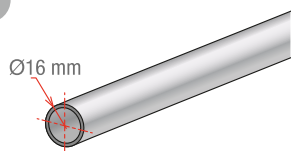

Tubo in alluminio di sospensione

code	L.	Ø	materiale	pack
	mm	mm		pcs/box
710500	1500	16	Alluminio anodizzato	10



146

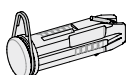

Tappo di chiusura con gancio

In plastica, con sistema a molla.

code	Ø	materiale	pack
	mm		pcs/box
710580	16	Alluminio anodizzato	10

Accessori

147

Giunto diretto con gancio

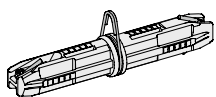

Per unire 2 tubi. Con sistema a molla.

code	Ø	colore	pack
	mm		pcs/box
710582	16	Grigio RAL9006	10

148

Giunto a 90° con gancio

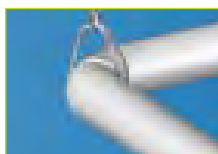
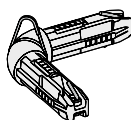

Per unire 2 tubi. Con sistema a molla.

code	Ø	colore	pack
	mm		pcs/box
710584	16	Grigio RAL9006	10

149

Giunto a T con gancio

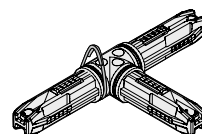

Per unire 3 tubi. Con sistema a molla.

code	Ø	colore	pack
	mm		pcs/box
710586	16	Grigio RAL9006	10

150

Giunto "Cross" con gancio

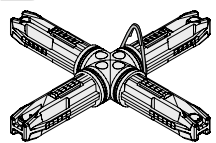

Per unire 4 tubi. Con sistema a molla.

code	Ø	colore	pack
	mm		pcs/box
710588	16	Grigio RAL9006	10

151

Gancio per appendere

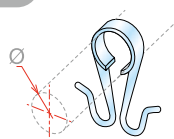

In plastica trasparente.

code	Ø	colore	pack
	mm		pcs/box
710602	16	Trasparente	20

152

Gancio per appendere a pressione

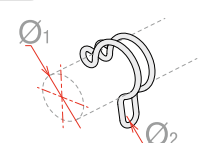

In metallo.

code	Ø ₁	Ø ₂	materiale	pack
	mm	mm		pcs/box
710603	16	5	Metallo	20



Altri accessori disponibili su www.synco.it

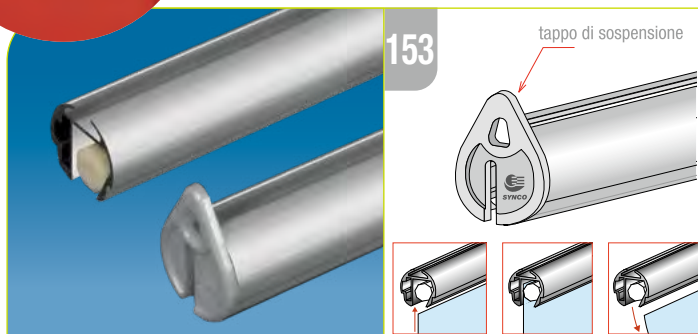

Barra FAST CLIP per cartelli singoli

Completa di tappi con occhiello per la sospensione e cilindretti autobloccanti per sospendere poster in carta. Altre lunghezze o colori su richiesta.

code	L.	Ø	materiale	pack
	mm	mm		pcs/box
711078	500	26	Alluminio anodizzato	5
711080	700	26	Alluminio anodizzato	5
711082	1000	26	Alluminio anodizzato	5
711084	1400	26	Alluminio anodizzato	5

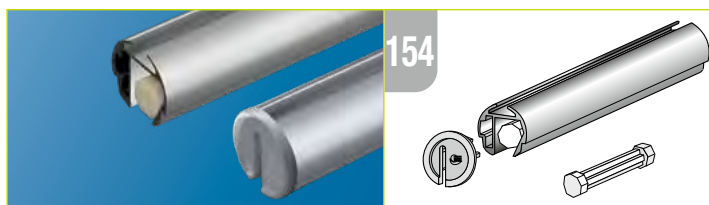

Barra FAST CLIP completa di tappi e cilindretti standard

code	L.	Ø	materiale	pack
	mm	mm		pcs/box
711130	3050	26	Alluminio anodizzato	5
711599	Su misura	26	Alluminio anodizzato	5

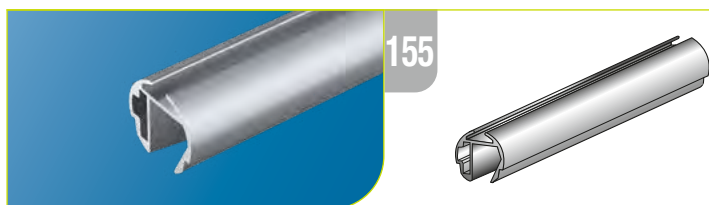

Barra FAST CLIP - solo barra

code	L.	Ø	materiale	pack
	mm	mm		pcs/box
711254	3050	26	Alluminio anodizzato	5
711799	Su misura	26	Alluminio anodizzato	5

Accessori

156 Tappi di chiusura

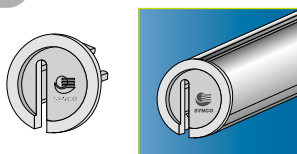

Coppia di tappi di chiusura in plastica.

code	Ø	colore	pack
	mm		pcs/box
711030	26	Grigio RAL9006	20

157 Tappi di chiusura con foro sospensione

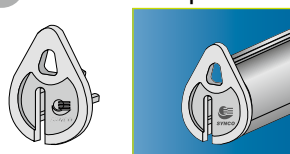

Coppia di tappi di chiusura in plastica.

code	Ø	colore	pack
	mm		pcs/box
711032	26	Grigio RAL9006	20

158 Gancio per la sospensione

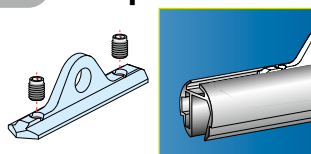

Gancio in plastica completo di viti di fissaggio.

code	colore	pack
		pcs/box
711023TR	Trasparente	20

159 Kit giunto diritto

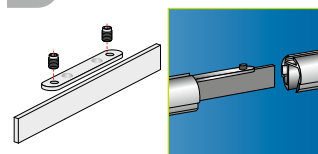

Kit in metallo completo con viti di fissaggio.

code	pack
	pcs/box
711106	10

160 Kit giunto diritto con foro sospensione

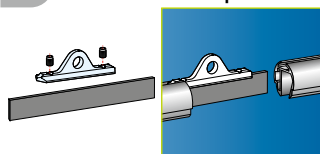

Gancio in plastica con viti di fissaggio.

code	colore	pack
		pcs/box
711109	Trasparente	10

161 Kit giunto a 90° con foro sospensione

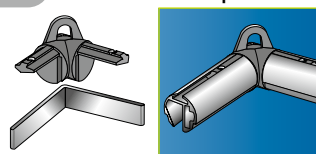

Gancio in plastica con viti di fissaggio.

code	colore	pack
		pcs/box
711025	Grigio RAL9006	10

162 Kit giunto a T con foro sospensione

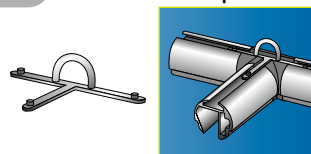

Gancio in metallo con viti di fissaggio.

code	colore	pack
		pcs/box
711026	Grigio RAL9006	10

163 Tubo per banner a tasche

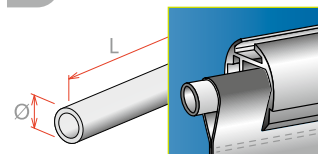

Tubo alluminio per banner con tasche.

code	Ø	L	pack
	mm	mm	pcs/box
710513	13	Su misura	10



Altri sistemi disponibili su www.synco.it



164

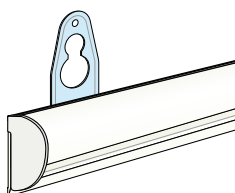

Semibarra FAST CLIP con gancetti

Completa di tappi e cilindretti autobloccanti per sospendere poster. Ganci per fissaggio a muro o con ventose, venduti separatamente.

code	descrizione	L. mm	materiale	pack pcs/box
711182	Semibarra	500	Bianco RAL9010	5
711072	Semibarra	700	Bianco RAL9010	5
711074	Semibarra	1000	Bianco RAL9010	5
711076	Semibarra	1400	Bianco RAL9010	5
723020	Gancio		Trasparente	10

Attacchi a soffitto



165

Adesivo schiuma Ø18 mm



Clip tonda adesiva per pesi fino a 250 g

code	misura mm	carico massimo g	colore	pack pcs/box
723098	Ø 20	250	Bianco	100



166

Adesivi schiuma Ø18 mm

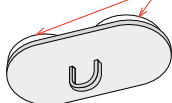

Clip doppia adesiva per pesi fino a 500 g

code	misura mm	carico massimo g	colore	pack pcs/box
723044	20 x 40	500	Bianco	50

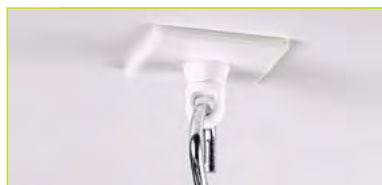

167

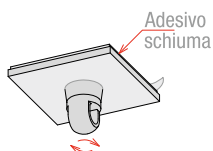

Bottone adesivo da soffitto girevole

code	misura mm	colore	pack pcs/box
723100	29 x 29	Bianco	100



168

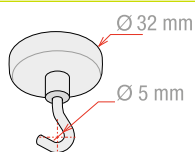

Magnete tondo Ø32 mm in metallo forza 8 kg con gancio

code	Ø mm	forza kg	colore	pack pcs/box
715015	32	8	Bianco	20



169

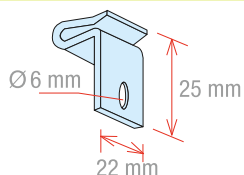

Clip in nylon per controsoffitto

code	colore	pack pcs/box
723022	Opalino	20



170

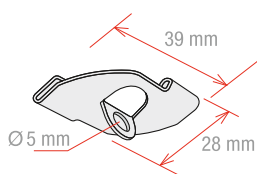

Clip in metallo per controsoffitti per carichi pesanti

code	colore	pack pcs/box
723039	Bianco	20



171

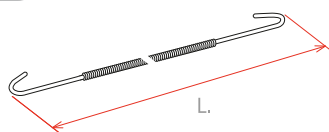

Molla estensibile

Per appendere rotairs, ecc.

code	L	L. max	per pesi fino a	materiale	pack
	mm	mm	kg		pcs/box
722012	170	1500	1,0	Metallo	100
722014	200	1500	3,5	Metallo	50



172

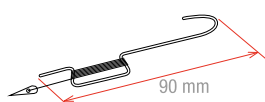

Gancio con filo srotolabile ed ago

Con filo in nylon e ago in metallo. Riutilizzabile.

code	L.max	materiale	pack
	mm		pcs/box
721028	1500	Metallo	10



173

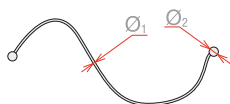

Filo con pallino per unione rotairs

Si adatta ai rotairs provvisti di apposite fenditure. Anche nelle misure: 40/50/60/70/80/90/100/110/120/130/140/150/160/170/180/200 mm. Altre misure su richiesta.

code	L	Ø1	Ø2	pack
	mm	mm	mm	pcs/box
722020	100	0,14	1/1,5	500

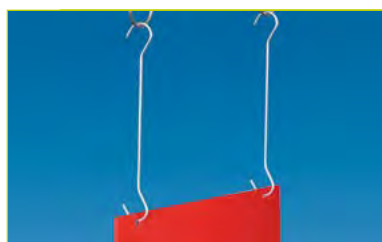

174

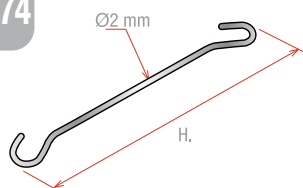

Ganci doppi universali Ø 2 mm

code	H	code	H
	mm		mm
725000	150	725006	700
725002	300	725008	1000
725004	500	725010	2000



175

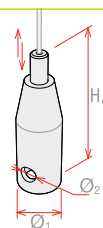

Stringifilo con regolazione a frizione

Stringifilo con foro con frizione per cavo in nylon o in acciaio da Ø 0,8 mm a Ø 1,5 mm. **NB:** Da utilizzare con gancio a "C" code 721036.

code	Ø1	Ø2	H.	materiale	pack
	mm	mm	mm		pcs/box
726016	8,0	2,8	25	Metallo	==



176

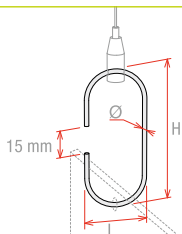

Gancio a "C" porta pannelli

Gancio in metallo da utilizzare con stringifilo code 726016.

code	L.	H.	Ø	materiale	pack
	mm	mm	mm		pcs/box
721036	33	76	2,3	Metallo	==

177

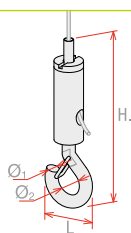

Gancio apribile per cavo con regolazione a frizione

Stringifilo con foro con frizione per cavo in nylon o in acciaio Ø 0,8 mm.

code	Ø1	Ø2	L.	H.	materiale	pack
	mm	mm	mm	mm		pcs/box
251260	4,0	10,5	18,5	58	Metallo	==



178

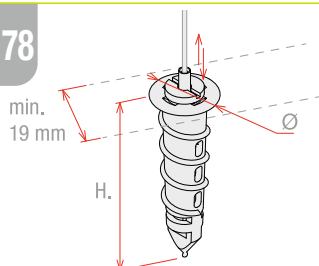

Vite per pannello sandwich con frizione

Vite per pannelli di spessore minimo 19 mm con frizione per regolazione altezza cavo di Ø max 1,5 mm.

code	Ø	H.	materiale	pack
	mm	mm		pcs/box
741202	18	50	Metallo	==

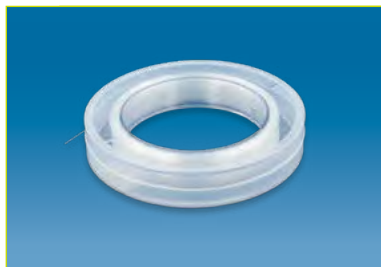

179

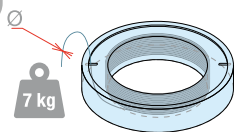

Rotolo di filo in nylon

code	Ø	materiale	rotolo
	mm		m
724017	0,4	Nylon	200
724018	0,8	Nylon	59



180

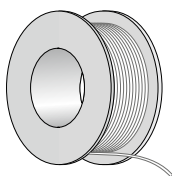

Cavo in acciaio zincato

code	Ø	materiale	rotolo
	mm		m
724011	0,8	Acciaio zincato	100
724009	1,5	Acciaio zincato	50



181



Stringifilo in alluminio per fissaggio

code	materiale	pack
		pcs/box
726305	Alluminio	100



182

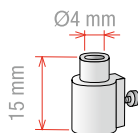

Stringifilo con vite di regolazione

code	Ø foro	materiale	pack
	mm		pcs/box
726014	4,0	Alluminio	100

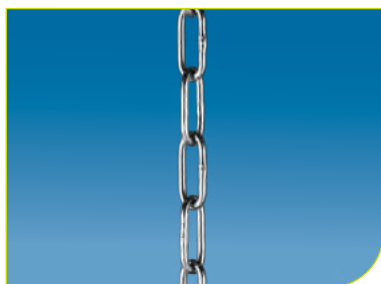

183

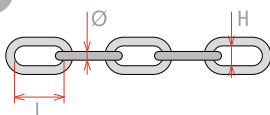

Catenella in metallo zincato

code	Ø	L	H	rotolo
	mm	mm	mm	m
724006	2,5	10,0	3,0	50
724008	3,0	12,5	3,5	50



184

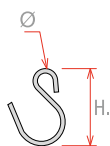

Gancio ad "S" medio aperto in metallo H.30 mm

code	H.	Ø	materiale	pack
	mm	mm		pcs/box
721008	30	2,0	Metallo	100



185

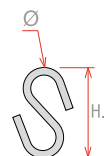

Gancio ad "S" in metallo H.24 mm

code	H.	Ø	materiale	pack
	mm	mm		pcs/box
721002	24	2,4	Metallo	100



186

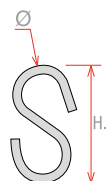

Gancio ad "S" in metallo H.34 mm

code	H.	Ø	materiale	pack
	mm	mm		pcs/box
721009	34	3,0	Metallo	20



187

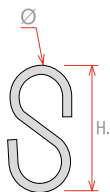

Gancio ad "S" in metallo H.40 mm

Non è adatto alla catenella code 724006.

code	H.	Ø	materiale	pack
	mm	mm		pcs/box
721010	40	3,8	Metallo	100



188

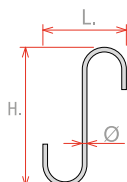

Gancio ad "S" in metallo H.60 mm

code	LxH.	Ø	materiale	pack
	mm	mm		pcs/box
721013	38xH.60	2	Metallo	1000



189

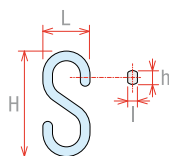

Gancio ad "S" in plastica trasparente

code	LxH.	lxh.	colore	pack
	mm	mm		pcs/box
721038	18xH.38	2,8xh.3,4	Trasparente	==
721037	25xH.55	4,0xh.5,0	Trasparente	==



190

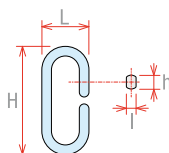

Gancio ad "C" in plastica trasparente H.40 mm

code	LxH.	lxh	colore	pack
	mm	mm		pcs/box
721014	18xH.40	3,8xh.5,0	Trasparente	==

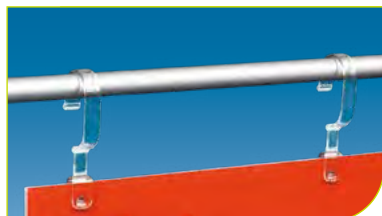

191

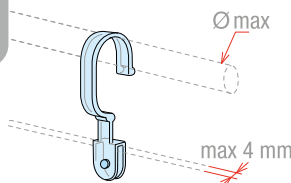

Gancio ad innesto su foro

code	spessori	Ømax	colore	pack
	mm	mm		pcs/box
744042	Fino a 4	20	Trasparente	20
744045	Fino a 4	28	Trasparente	20



192

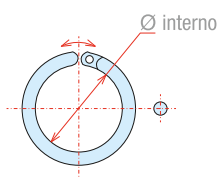

Anello richiudibile in plastica - trasparente

code	Ø interno chiuso	colore	pack
	mm		pcs/box
723013	17,5	Trasparente	==
723015	21,0	Trasparente	==



193

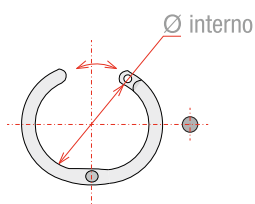

Anello in metallo richiudibile

code	Ø interno	materiale	pack
	mm		pcs/box
721017	18,0	Metallo	100
721018	21,0	Metallo	100
721020	25,0	Metallo	100
721022	32,0	Metallo	100
721024	38,0	Metallo	100
721026	51,0	Metallo	100



194

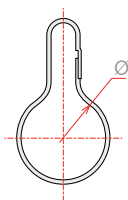

Anello a pera, chiudibile a pressione

code	Ø interno	materiale	pack
	mm		pcs/box
723024	23,0	Metallo	100
723058	35,0	Metallo	100

Ventose



195

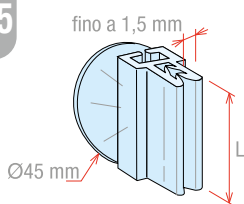

Gripper con ventosa

code	Ø	L	per spessori	colore	pack
	mm	mm	mm		pcs/box
797120	45	45	Fino a 1,5	Trasparente	100



196

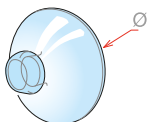

Ventosa con sporgenza

code	Ø	colore	pack
	mm		pcs/box
714002	22	Trasparente	==
714005	40	Trasparente	==



197

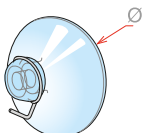

Ventosa con gancio in metallo

code	Ø	colore	pack
	mm		pcs/box
714004	42	Trasparente	==



198

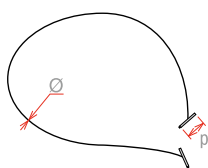

Elastico con capicorda

code	L	p	Ø	colore	pack
	mm	mm	mm		pcs/box
724102	320	17	2,5	Nero	==

Altre misure e colori su richiesta.



199

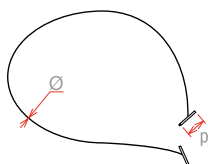

Cordino con capicorda

code	L	p	Ø	colore	pack
	mm	mm	mm		pcs/box
724104	240	17	2,0	Bianco	==

Altre misure e colori su richiesta.

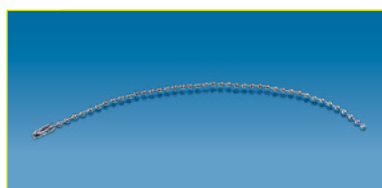

200

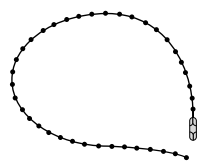

Legame catenella in metallo richiudibile

code	lunghezza	Ø	pack
	mm	mm	pcs/box
723201	150	2,5	1000

Altre misure e colori su richiesta.



201

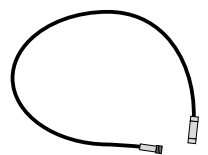

Legame cavo acciaio richiudibile

code	lunghezza	pack
	mm	pcs/box
723200	150	==



202

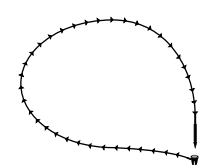

Laccio in nylon regolabile

code	lunghezza	colore	pack
	mm		pcs/box
723094	143	Bianco	1000



203

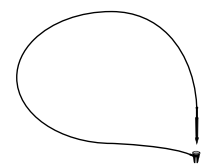

Laccio in nylon fisso

code	lunghezza	colore	pack
	mm		pcs/box
723096	125	Bianco	1000

Altre misure su richiesta.



204

Adesivo schiuma Ø18 mm



Clip tonda adesiva per pesi fino a 250 g

code	Ø	adesivo	colore	pack
	mm			pcs/box
723098	20	Schiuma	Bianco	100

Bustine



205

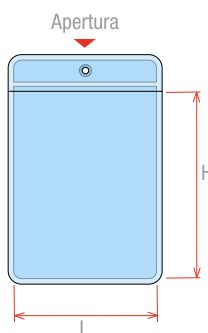

Bustina in PVC morbido

code	formato	inserto	fori	pack
		mm	nr	pcs/box
241071	==	55 x H.120	1	100
241073	==	80 x H.120	1	100
241067	A7	74 x H.105	1	100
241065	A6	105 x H.148	1	100

Maniglie



206

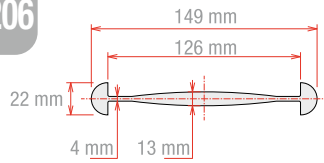

Maniglia

code	colore	pack
724202	Bianco	==

207

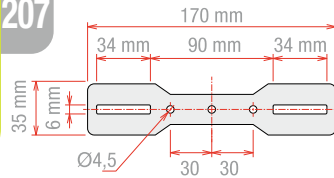

Contromaniglia

code	colore	pack
724204	Bianco	==

Antifurti



208

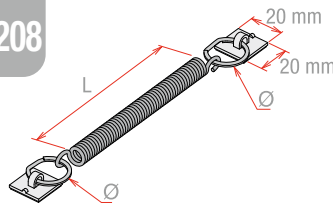

Antifurto a spirale in plastica con 2 bottoni adesivi

code	L.	Ø	colore	pack
	mm	mm		pcs/box
842671	Da 105 fino a 800	20	Spirale grigio - Bottoni bianco	==



209

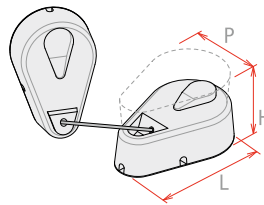

Antifurto con cavo in metallo estraibile

Adesivo, con riposizionamento magnetico.

code	LxPxH.	forza	cavo	colore	pack
	mm	g	mm		pcs/box
842672	55x35xH.28	150	900	Bianco	==



210

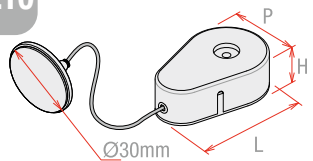

Antifurto con cavo in metallo estraibile

Adesivo, cavo con bottone adesivo.

code	LxPxH.	forza	cavo	colore	pack
	mm	g	mm		pcs/box
842674	50x33xH.16	150	850/900	Grigio	==



211

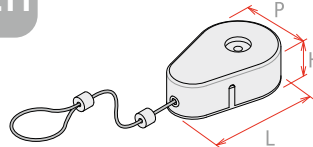

Antifurto con cavo in metallo estraibile

Adesivo, cavo con asola. Con brugola per regolazione asola.

code	LxPxH.	forza	cavo	colore	pack
	mm	g	mm		pcs/box
842676	50x33xH.16	150	850/900	Grigio	==



212

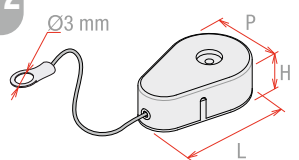

Antifurto con cavo in metallo estraibile

Adesivo, con estremità ad occhiello.

code	LxPxH.	forza	cavo	colore	pack
	mm	g	mm		pcs/box
842678	50x33xH.16	150	850/900	Grigio	==

NEW

213

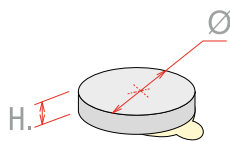

Pastiglia magnetica tonda con adesivo

Se i magneti sono usati uno contro l'altro: ordinare la stessa quantità di polo Nord e Sud. Se sono usati per applicazione contro parti metalliche: ordinare indifferentemente dalla polarità.

code	code	Ø	H	pack
polarità Nord (+)	polarità Sud (-)	mm	mm	pcs/box
715213N	715213S	9,5	0,75	==
715214N	715214S	9,5	1,5	==
715216N	715216S	10,0	1,0	==
715209N	715209S	13,0	1,0	==
715218N	715218S	18,0	1,0	==

214

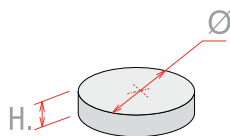
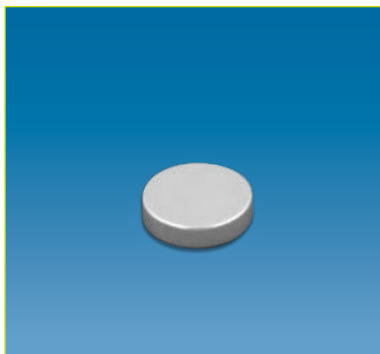

Pastiglia magnetica tonda

code	Ø	H	pack
	mm	mm	pcs/box
715200	9,5	1,0	500
715202	9,5	1,5	500
715204	9,5	2,0	500
715206	12,0	1,5	500
715208	12,0	2,0	500
715210	15,0	2,0	500
715212	20,0	2,0	500

215

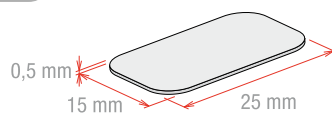
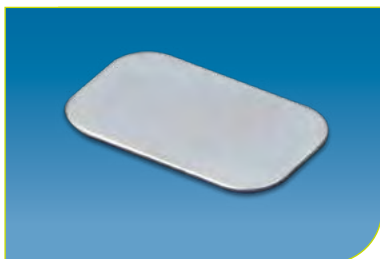

Contropiastra per pastiglia magnetica

code	dimensioni	materiale	pack
	mm		pcs/box
715299	25 x 15	Lamierino zincato 5/10	500

Basi girevoli

216

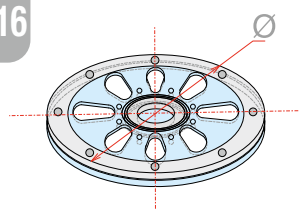

Base girevole in plastica - Ø 140 mm

code	Ø	colore	pack
	mm		pcs/box
842262WH	140	Bianco	==
842262TR	140	Trasparente	==
842262BK	140	Nero	==

217

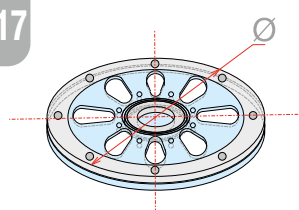

Base girevole in plastica - Ø 215 mm

code	Ø	colore	pack
	mm		pcs/box
842264WH	215	Bianco	==
842264TR	215	Trasparente	==
842264BK	215	Nero	==

Produciamo anche espositori su misura utilizzando frese CNC, laser e piegatrici.
Altri modelli disponibili su www.synco.it



218 Espositore a "L" inclinato - monofacciale

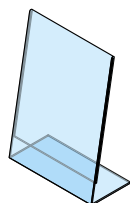

In PETG (materiale antiurto) o acrilico trasparente, piegato a caldo.

code	DIN	inserto	posizione	materiale	spessore	pack
		mm			mm	pcs/box
242042	A5	148 x H.210	Verticale	PETG	1,5	10
242040	A4	210 x H.297	Verticale	PETG	2,0	10
242062	A4	210 x H.297	Verticale	Acrilico	2,0	10

219 Espositore a "L" inclinato a 2 posizioni - monofacciale

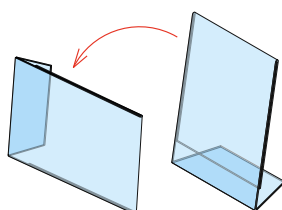

La base trapezoidale permette il suo utilizzo anche in orizzontale.

code	DIN	inserto	materiale	spessore	pack
		mm		mm	pcs/box
242086	A5	148 x H.210	PS	1,6	12
242088	A4	210 x H.297	PS	1,6	12

220 Espositore a "T" - bifacciale

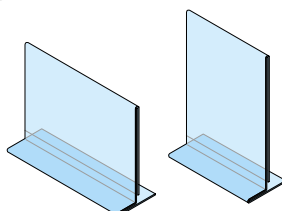

In PETG (materiale antiurto) o acrilico trasparente, piegato a caldo.

code	DIN	inserto	posizione	materiale	spessore	pack
		mm			mm	pcs/box
242082	A5	148 x H.210	Verticale	PETG	1,5	10
242080	A4	210 x H.297	Verticale	PETG	2,0	10
242100	A4	210 x H.297	Verticale	Acrilico	2,0	10

221 Contenitore a sfera

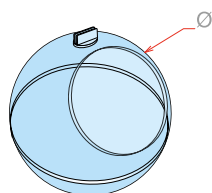

Contenitore da appoggio in plastica.
Fornito di clip porta messaggio, da applicare.

code	Ø	colore	pack
	mm		
812791	200	trasparente	1



222 Tasca a "C" inserimento laterale - monofacciale - adesiva

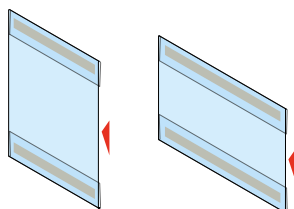

code	DIN	inserto	posizione	materiale	spessore	pack
		mm			mm	
242728	A6	105 x H.148	Verticale	PVC lucido	0,4	20
242730	A6	148 x H.105	Orizzontale	PVC lucido	0,4	20
242724	A5	148 x H.210	Verticale	PVC lucido	0,4	20
242726	A5	210 x H.148	Orizzontale	PVC lucido	0,4	20
242720	A4	210 x H.297	Verticale	PVC lucido	0,4	20
242722	A4	297 x H.210	Orizzontale	PVC lucido	0,4	20
242725	A3	297 x H.420	Verticale	PVC lucido	0,4	20
242727	A3	420 x H.297	Orizzontale	PVC lucido	0,4	20

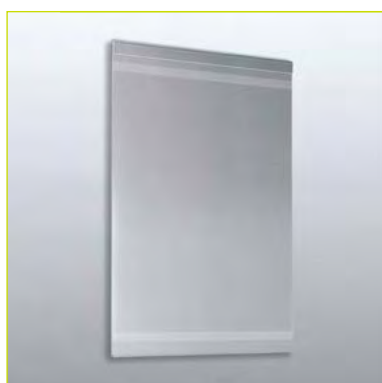

223 Tasca per cambio messaggio facilitato - monofacciale - adesiva

L'apertura sul fronte permette una rapida sostituzione.

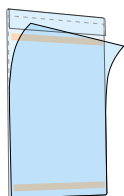

code	DIN	inserto	posizione	materiale	spessore	pack
		mm			mm	
242800	A4	210 x H.297	Verticale	PVC antiriflesso	0,4	10
242806	A4	297 x H.210	Orizzontale	PVC antiriflesso	0,4	10
242802	A3	297 x H.420	Verticale	PVC antiriflesso	0,4	10
242808	A3	420 x H.297	Orizzontale	PVC antiriflesso	0,4	10
242804	A2	420 x H.594	Verticale	PVC antiriflesso	0,65	10
242810	A2	594 x H.420	Orizzontale	PVC antiriflesso	0,65	10



224 Tasca riposizionabile a "C" inserimento laterale - monofacciale

Tasca riposizionabile con sistema "attacca - stacca". Non lascia residui.

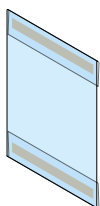

code	DIN	inserto	posizione	materiale	spessore	pack
		mm			mm	
242720AR	A4	210 x H.297	Verticale	PVC antiriflesso	0,4	10
242720R	A4	210 x H.297	Verticale	PVC lucido	0,4	10
242724AR	A5	148 x H.210	Verticale	PVC antiriflesso	0,4	10
242724R	A5	148 x H.210	Verticale	PVC lucido	0,4	10



225 Tasca magnetica a "C" inserimento laterale - monofacciale

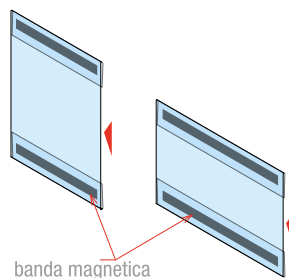

banda magnetica

code	DIN	inserto	posizione	materiale	spessore	pack
		mm			mm	
242248		70 x H.297	Verticale	PVC lucido	0,4	50
242258		297 x H.70	Orizzontale	PVC lucido	0,4	50
242246		105 x H.210	Verticale	PVC lucido	0,4	50
242256		210 x H.105	Orizzontale	PVC lucido	0,4	50
242244	A6	105 x H.148	Verticale	PVC lucido	0,4	50
242254	A6	148 x H.105	Orizzontale	PVC lucido	0,4	50
242242	A5	148 x H.210	Verticale	PVC lucido	0,4	50
242252	A5	210 x H.148	Orizzontale	PVC lucido	0,4	50
242240	A4	210 x H.297	Verticale	PVC lucido	0,4	50
242250	A4	297 x H.210	Orizzontale	PVC lucido	0,4	50

226 Porta brochures da banco

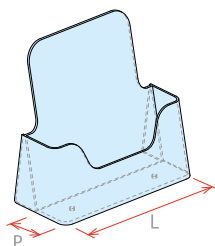

code	formato	misure interne		misure esterne		pack
		mm		mm		pcs/box
242550	1/3 A4 Verticale	103x31 xH.182		109x65xH.185		==
242552	A5 Verticale	158x38xH.171		172x75xH.174		==
242554	A4 Verticale	222x38xH.247		240x93xH.250		==

227 Porta brochures da muro

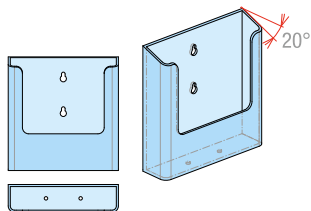

code	formato	misure interne		misure esterne		pack
		mm		mm		pcs/box
242560	1/3 A4 Verticale	105x34xH.162		112x40xH.164		==
242562	A5 Verticale	153x34xH.162		159x40xH.164		==
242564	A4 Verticale	216x34xH.247		224x40xH.250		==

228 Porta brochures da muro - orizzontale

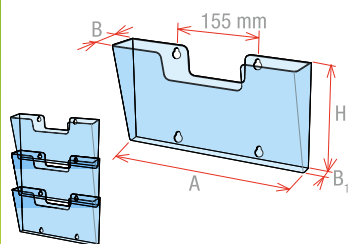

Singoli o sovrapponibili per esposizione multipla.

code	inserto	A	B	B ₁	H.	pack
		mm	mm	mm	mm	pcs/box
242548	A4 297 xH.210	355	72	28	180	4

229 Porta brochures multipli

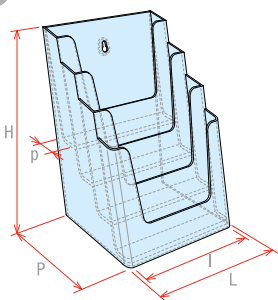

code	formato	livelli	misure interne		misure esterne		pack
			mm		mm		pcs/box
242570	1/3 A4 Verticale	4	105x34xH.162		112x40xH.164		==
242572	A5 Verticale	4	153x34xH.162		159x40xH.164		==
242574	A4 Verticale	3	216x34xH.247		224x40xH.250		==

230 Porta biglietti da visita da banco

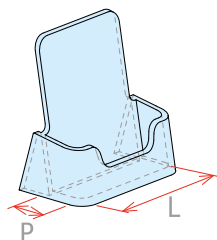

In polistirene trasparente.

code	modello	misure interne mm	misure esterne mm	pack pcs/box
242582	Verticale	55x16	62x35xH.67	==
242584	Orizzontale	108x19	114x25xH.48	==

231 Porta biglietti da visita da parete

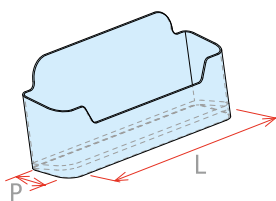

In polistirene trasparente.

code	modello	misure interne mm	misure esterne mm	pack pcs/box
242586	Orizzontale	108x19	114x23xH.48	==

232 Porta nome con spilla

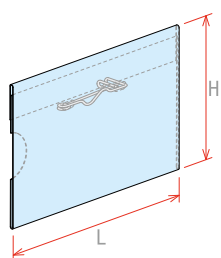

Porta nome con spilla di sicurezza. Inserto formato carta di credito.

code	L x H. mm	materiale	spessore mm	pack pcs/box
439010	88 x H.56	PVC lucido	0,30	==

233 Porta nome con clip e spilla

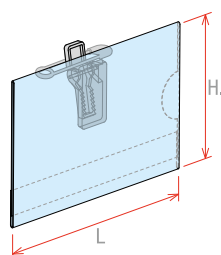

Porta nome con clip e spilla di sicurezza. Inserto formato carta di credito.

code	L x H. mm	materiale	spessore mm	pack pcs/box
439012	88 x H.56	PVC lucido	0,30	==

Ampia gamma disponibile su www.synco.it



234



Cornice verticale - apertura lato corto

code	inserto mm	posizione	colore	pack pcs/box
610812	A4 - 210 x H.297	Verticale	Trasparente	10
611212	A3 - 297 x H.420	Verticale	Trasparente	10



235

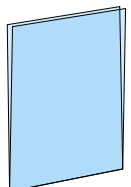

Busta protettiva trasparente per cornice

code	cornice mm	materiale	spessore mm	pack pcs/box
744167	A4 - Verticale	PVC antiriflesso	0,20	10
744169	A3 - Verticale	PVC antiriflesso	0,20	10



236

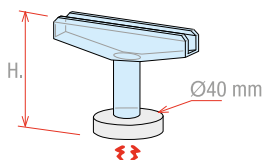

Supporto magnetico - per cornice

code	H. mm	forza magneti kg	colore	pack pcs/box
772088	50	13	Trasparente	10



237



Asta telescopica SILVER - per cornice

In alluminio con tubi Ø 10 e Ø 13 mm, con frizione di bloccaggio.

code	estensibile mm	colore	pack pcs/box
842118	da 300 a 550 mm	Grigio RAL9006	10
842120	da 500 a 950 mm	Grigio RAL9006	10

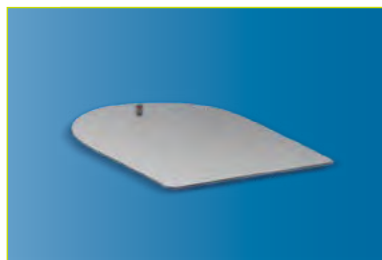

238

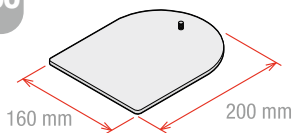

Base in acciaio verniciata

Attacco a vite, verniciatura epossidica colore alluminio RAL 9006.

code	L x H. mm	colore	pack pcs/box
842198	160 x 200	Grigio RAL9006	10



239

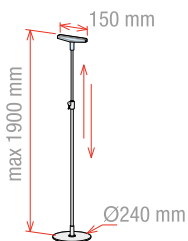

Piantana telescopica MAGNUM per cornici

Asta telescopica in alluminio, tubi Ø 13 e 16 mm. Base Ø 240 mm in acciaio, verniciatura epossidica colore alluminio RAL 9006..

code	estensibile mm	colore	pack pcs/box
774000	da 1000 a 1900 mm	Grigio RAL9006	10

240 Asta telescopica SILVER con supporto a pinza ELITE

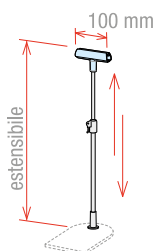
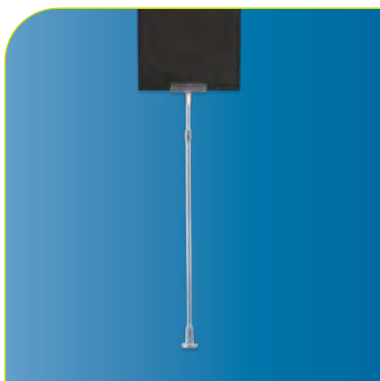

Per comunicazioni di spessore da 1 a 5 mm.
In alluminio con tubi \varnothing 10 e \varnothing 13 mm, con frizione di bloccaggio.
Disponibile tasca porta messaggio A4 verticale in PETG da 1,5 mm (code 242068), venduta a parte (altri formati a richiesta).

code	estensibile mm	colore	pack pcs/box
842118E	da 300 a 550 mm	Grigio RAL9006	10
842120E	da 500 a 950 mm	Grigio RAL9006	10

241 Base in acciaio verniciata

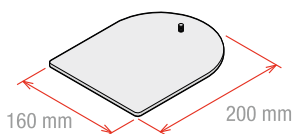
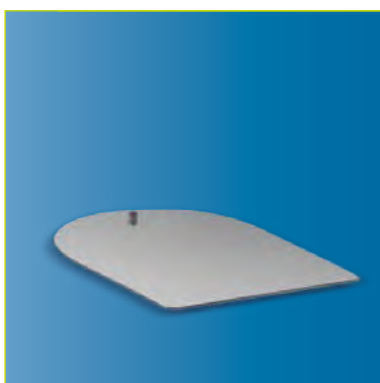

Attacco a vite, verniciatura epossidica colore alluminio RAL 9006.

code	LxH. mm	colore	pack pcs/box
842198	160 x 200	Grigio RAL9006	10

242 Piantana telescopica MAGNUM con pinza ELITE

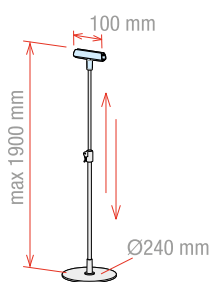

Per comunicazioni di spessore da 1 a 5 mm.
Asta telescopica in alluminio, tubi \varnothing 13 e 16 mm.
Base \varnothing 240 mm in acciaio,
Verniciatura epossidica colore alluminio RAL 9006.
Disponibile tasca porta messaggio A4 verticale in PETG da 1,5 mm (code 242068), venduta a parte (altri formati a richiesta).

code	estensibile mm	colore	pack pcs/box
774057	da 1000 a 1900 mm	Grigio RAL9006	10

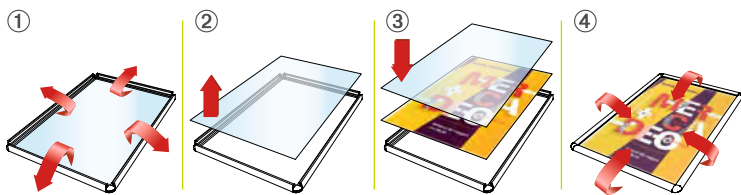

243 Cornice CLIC in alluminio da parete o soffitto

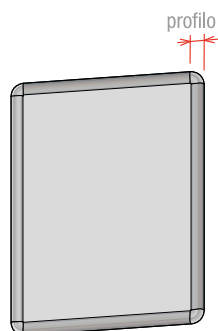

Utilizzabile sia in verticale sia in orizzontale. Dotata di profilo con apertura a scatto di spessore 25 o 32 mm. Con angoli tondi cromati. Comprensiva di foglio di protezione antiriflesso.

code	formato	inserto mm	profilo mm	pack pcs/box
813006CR25	A4	210x297	25	1
813005CR25	A3	297x420	25	1
813007CR25	A2	420x594	25	1
813000CR25		500x700	25	1
813024CR25	A1	594x840	25	1
813001CR25		700x1000	25	1
813026CR32	A0	840x1188	32	1
813002CR32		1000x1400	32	1

244 Piantana stand board CLIC in alluminio

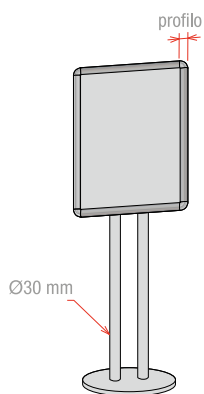

Profilo con apertura a scatto di spessore 25 o 32 mm. Con angoli tondi cromati. Base in acciaio. Comprensiva di foglio di protezione antiriflesso.

code	inserto mm	lati	profilo mm	pack pcs/box
813008CR25	500x700	monofacciale	25	1
813018CR25	500x700	bifacciale	25	1
813009CR25	700x1000	monofacciale	25	1
813020CR25	700x1000	bifacciale	25	1
813048CR32	1000x1400	monofacciale	32	1
813022CR32	1000x1400	bifacciale	32	1

245 Cornice CLIC struttura a cavalletto - bifacciale

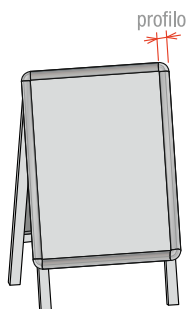

Profilo con apertura a scatto di spessore 25 o 32 mm. Con angoli tondi cromati. Base in acciaio. Comprensiva di foglio di protezione antiriflesso.

code	inserto mm	lati	profilo mm	pack pcs/box
813003CR25	500x700	bifacciale	25	1
813003CR32	500x700	bifacciale	32	1
813004CR32	700x1000	bifacciale	32	1
813013CR32	1000x1400	bifacciale	32	1



246 Banda magnetica adesiva in rotolo

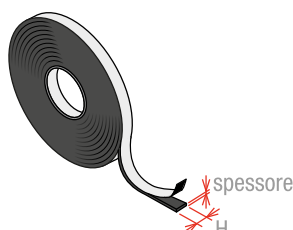

code	H.	spessore	rotolo
	mm	mm	m
798008	10	1,5	30
798002	15	1,5	30
798004	20	1,5	30

NB: Altre misure su richiesta.



247 Biadesivo trasparente in rotolo

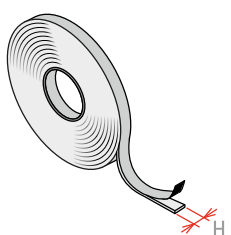

code	H.	colore	rotolo
	mm		m
461500	9	Trasparente	50
461502	12	Trasparente	50
461503	19	Trasparente	50

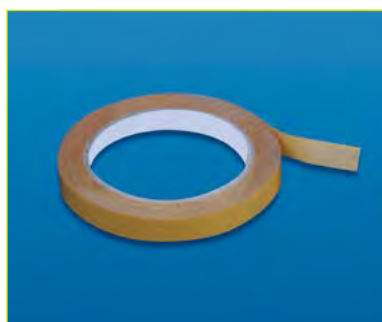

248 Biadesivo trasparente removibile in rotolo

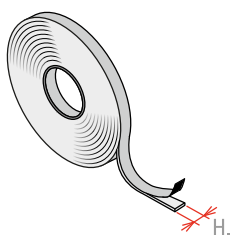

code	H.	colore	rotolo
	mm		m
461510	9	Trasparente	50



249 Bollino biadesivo schiuma

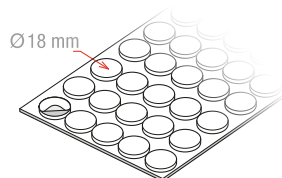

code	Ø	spessore	colore	foglio
	mm	mm		pcs
723048	18,0	0,8	Bianco	50



250 Biadesivo schiuma in rotolo

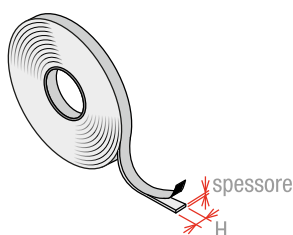

code	H.	spessore	colore	rotolo
	mm	mm		m
461520	9	1,0	Bianco	50
461522	12	1,0	Bianco	50
461524	19	1,0	Bianco	50
461526	25	1,0	Bianco	50



251 Bollino colla in rotolo

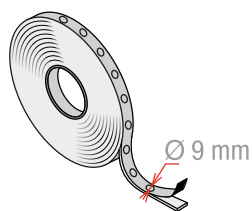

code	tipo	Ø	colore	rotolo
		mm		pcs/rotolo
917102	Removibile	9,0	Trasparente	2000
917104	Semiremovibile	9,0	Trasparente	2000
917106	Permanente	9,0	Trasparente	2000

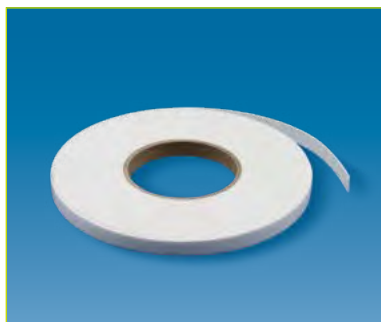

252 Adesivo-non adesivo schiuma riutilizzabile per applicazioni a superfici lisce

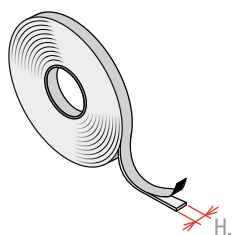

Con proprietà stacca-attacca, utile per comunicazioni o messaggi che necessitano un riposizionamento.

code	H	colore	rotolo
	mm		m/rotolo
917202	12	Bianco	20



253 Velcro adesivo in rotolo

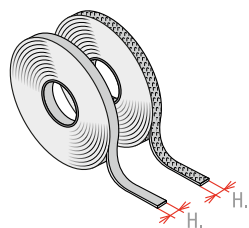

Maschio e femmina separati.

code	descrizione	H.	colore	rotolo
		mm		m
461530	Maschio + Femmina	20	Bianco	25
461531	Maschio + Femmina	25	Bianco	25



254 Bollino in velcro adesivo in rotolo

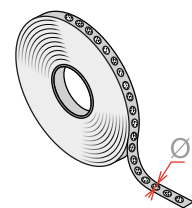

Già accoppiato maschio e femmina.

code	Ø	colore	rotolo
	mm		pcs/rotolo
461534WH	13,0	Bianco	1500
461536WH	19,0	Bianco	1120
461534BK	13,0	Nero	1500
461536BK	19,0	Nero	1120

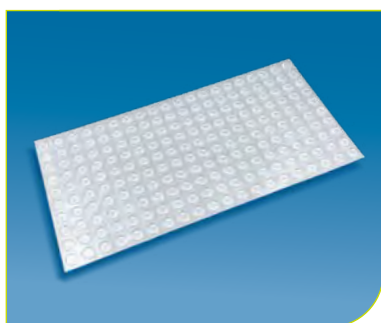

255 Piedino in gomma trasparente adesivo

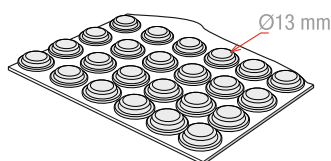

code	Ø	spessore	colore	foglio
	mm	mm		pcs
723049134	13,0	4	Trasparente	200

NB: Altre misure e colori su richiesta.

codice	prodotto
111646	38
111652	41
111802	44
111804	45
111810	109
117770	39
117772	40
117774	39
117776	40
117778	39
117780	40
170017	87
241065	205
241067	205
241071	205
241073	205
242040	218
242042	218
242062	218
242070	122
242080	220
242082	220
242086	219
242088	219
242100	220
242240	225
242242	225
242244	225
242246	225
242248	225
242250	225
242252	225
242254	225
242256	225
242258	225
242548	228
242550	226
242552	226
242554	226
242560	227
242562	227
242564	227
242570	229
242572	229
242574	229
242582	230
242584	230
242586	231

codice	prodotto
242720	222
242722	222
242724	222
242725	222
242726	222
242727	222
242728	222
242730	222
242800	223
242802	223
242804	223
242806	223
242808	223
242810	223
243080	119
251042	23
251052	31
251054	32
251056	33
251144	22
251145	22
251245	7
251260	177
251900	34
251902	35
251904	37
251906	36
262012	89
262017	90
439010	232
439012	233
461500	247
461502	247
461503	247
461510	248
461520	250
461522	250
461524	250
461526	250
461530	253
461531	253
610812	234
611212	234
630002	113
630050	120
630075	120
630100	120
630150	120

codice	prodotto
631050	121
631075	121
631100	121
631150	121
690402	104
710500	145
710508	144
710513	163
710580	146
710582	147
710584	148
710586	149
710588	150
710602	151
710603	152
711025	161
711026	162
711030	156
711032	157
711072	164
711074	164
711076	164
711078	153
711080	153
711082	153
711084	153
711106	140
711106	159
711109	141
711109	160
711130	154
711182	164
711254	155
711599	154
711799	155
711802	136
711809	136
711823	142
711830	138
711832	137
713000	135
713010	135
713050	134
713070	134
713100	134
714002	196
714004	197
714005	196

codice	prodotto
714020	88
714030	49
714032	49
714034	49
714035	48
714036	48
714040	50
714042	50
714052	52
714054	52
714056	52
714066	51
714068	51
714070	53
714072	53
714074	53
714076	53
714080	54
714082	54
714130	57
714180	58
714182	58
714204	59
714207	59
714210	59
715015	168
715200	214
715202	214
715204	214
715206	214
715208	214
715210	214
715212	214
715299	215
721002	185
721008	184
721009	186
721010	187
721013	188
721014	190
721017	193
721018	193
721020	193
721022	193
721024	193
721026	193
721028	172
721030	42

INDICE

codice	prodotto
721032	43
721036	176
721037	189
721038	189
722012	171
722014	171
722020	173
723013	192
723015	192
723020	164
723022	169
723024	194
723039	170
723044	166
723048	249
723058	194
723065	55
723066	55
723094	202
723096	203
723098	165
723098	204
723100	167
723200	201
723201	200
724006	183
724008	183
724009	180
724011	180
724017	179
724018	179
724102	198
724104	199
724202	206
724204	207
725000	174
725002	174
725004	174
725006	174
725008	174
725010	174
726014	182
726016	175
726305	181
741004	129
741005	129
741039	128
741202	178

codice	prodotto
744042	191
744045	191
744166	130
744167	235
744169	235
772068	118
772088	236
772157	117
774000	239
774057	242
792571	85
792574	86
792584	123
797108	103
797109	103
797110	103
797112	103
797120	102
797120	195
797126	111
797127	111
797128	111
797145	112
797147	110
797148	110
797153	106
797168	114
797169	114
797170	114
797172	115
797180	107
797182	108
797193	91
797195	105
797197	105
812791	221
841040	84
841207	82
841208	79
841250	83
841260	80
841280	81
841302	95
841304	96
841312	97
841320	99
842118	237
842120	237

codice	prodotto
842198	238
842198	241
842257	116
842638	19
842650	28
842652	28
842656	29
842658	29
842659	30
842664	4
842664	14
842664	20
842665	8
842671	208
842672	209
842674	210
842676	211
842678	212
851026	132
851028	132
851030	132
852000	133
852002	133
852004	133
852010	133
852011	134
915037	143
917102	251
917104	251
917106	251
917202	252
2512010	6
2512020	6
2512050	6
2512070	6
2512100	6
2512120	6
2512150	6
2512170	6
2512190	6
2512210	6
2512250	6
2512484	3
2512484	13
2513050	5
2513100	5
2513150	5
25110005	18

codice	prodotto
25110010	18
25110015	18
25110020	18
25110025	18
25110030	18
25110210	17
25110215	17
25110220	17
25110225	17
25110230	17
25113806	15
25113808	15
25113812	15
25113816	15
25113820	15
25114010	16
25114015	16
25114020	16
25114025	16
25114030	16
25125050	2
25125100	2
25125150	2
25125200	2
25126050	1
25126100	1
25126150	1
25126200	1
25145050	12
25145100	12
25145150	12
25145200	12
25146050	11
25146100	11
25146150	11
25146200	11
74417520	130
84132125	100
723049134	255
111804AS	45
242720AR	224
242720R	224
242724AR	224
242724R	224
251148WH	21
251149WH	21
311050BK	9
311050TR	9

codice	prodotto
311050WH	9
311100BK	9
311100TR	9
311100WH	9
311150BK	9
311150TR	9
311150WH	9
312020BK	10
312020TR	10
312020WH	10
312050BK	10
312050TR	10
312050WH	10
312070BK	10
312070TR	10
312070WH	10
312100BK	10
312100TR	10
312100WH	10
312120BK	10
312120TR	10
312120WH	10
312150BK	10
312150TR	10
312150WH	10
312170BK	10
312170TR	10
312170WH	10
321300BK	46
321300PL	46
321300SC	46
321300TR	46
321300WH	46
321302BK	47
321302PLA	47
321302TR	47
321302WH	47
461534BK	254
461534WH	254
461536BK	254
461536WH	254
711023TR	139
711023TR	158
714035WH	48
714036WH	48
714120BK	56
714120TR	56
714120WH	56

codice	prodotto
715209N	213
715209S	213
715213N	213
715213S	213
715214N	213
715214S	213
715216N	213
715216S	213
715218N	213
715218S	213
744008F	92
744008FAD	93
744008GTR	94
744166TR	130
813000CR25	243
813001CR25	243
813002CR32	243
813003CR25	245
813003CR32	245
813004CR32	245
813005CR25	243
813006CR25	243
813007CR25	243
813008CR25	244
813009CR25	244
813013CR32	245
813018CR25	244
813020CR25	244
813022CR32	244
813024CR25	243
813026CR32	243
813048CR32	244
841208BK	79
841260BK	80
841312F	98
842118E	240
842120E	240
842262BK	216
842262TR	216
842262WH	216
842264BK	217
842264TR	217

codice	prodotto
842264WH	217
852000TR	133
852002TR	133
852004TR	133
852010TR	133
B84132125	101
DMRAD00TR1000	76
DRRAD32NRTR1330	65
DRRAD32TR1000	77
DS00620TR1000	60
DS00626TR1000	60
DS00632TR1000	60
DS00640TR1000	60
DS00652TR1000	60
DS00660TR1000	60
DS01220TR1000	61
DS01225TR1000	61
DS0122624TR1000	61
DS01230TR1000	61
DS01230TR1330	61
DS0124025TR1330	61
DS0124036TR1330	61
DS01240TR1000	61
DS01250TR1000	61
DS01260TR1000	61
DS02432TR1000	62
DS02432TR1330	62
DS02440TR1000	62
DS02440TR1330	62
DS03032TR1000	63
DS03032TR1330	63
DS03040TR1000	63
DS03040TR1330	63
DS13200TR2660	71
DS17400TR1000	73
DS182NORA1000	66
DS182NORA1330	66
DS18320ANF1000	64
DS18600TR1000	72
DS19118TR1000	67
DS19332TR1000	68
DS19340TR1000	68

codice	prodotto
DS193NORA1000	66
DS193NORA1330	66
DS19800TR2000	69
DVBRKWS050380	74
DVBRKWS050480	74
DVBRKWS050580	74
DVMICWS050280	75
DVMICWS050380	75
DVMICWS050480	75
DVPUSSL01F280	78
DVPUSSL01F380	78
DVPUSSL01F480	78
DVPUSSL02F280	78
DVPUSSL02F380	78
DVPUSSL02F480	78
DVPUSSL03F280	78
DVPUSSL03F380	78
DVPUSSL03F480	78
LHH02000TR65	26
LHH02009TR50	27
LHH02009TR65	27
LHH02009TR70	27
LHH02009TR75	27
LHH05009TR75	25
LHH08010TR75	24
LHH50BARTR2660	70
SP25000SC	125
SP25050SC	125
SP25100SC	125
SP50000ST	126
SP50050ST	126
SP50100ST	126
SP55130PF	131
SP80000ST	127
SP80050ST	127
SP80100ST	127
SPSC000SC	124

La società Synco S.r.l. in funzione della costante evoluzione dei propri prodotti, si riserva il diritto di modificare in qualsiasi momento e senza preavviso gli articoli esposti in questo catalogo. Le misure di alcuni prodotti potrebbero subire variazioni al fine di ottimizzare i processi produttivi. Quest'ultimo non costituisce documento contrattuale.

Settembre 2021

Utilizzate foto di repertorio.

©2021 - Synco S.r.l. - Tutti i diritti riservati

SYNCO S.R.L.
Via G. Pastore. 30
21046 Gurone di Malnate (VA)
ITALY
T +39 0332 42 07 11
F +39 0332 42 52 47
sales@syncospa.com
www.syncopop.it